

A4000HardwareGuide

Warren Block

COLLABORATORS

	<i>TITLE :</i> A4000HardwareGuide		
<i>ACTION</i>	<i>NAME</i>	<i>DATE</i>	<i>SIGNATURE</i>
WRITTEN BY	Warren Block	February 12, 2023	

REVISION HISTORY

NUMBER	DATE	DESCRIPTION	NAME

Contents

1	A4000HardwareGuide	1
1.1	main	1
1.2	introduction	2
1.3	common problems	3
1.4	fan problems	4
1.5	-5v power problems	4
1.6	video banding problems	5
1.7	green display problems	5
1.8	other video problems	5
1.9	backplane problems	5
1.10	cable routing problems	6
1.11	battery problems	6
1.12	zorro-iii problems	6
1.13	scsi reselect problems	7
1.14	dead machine problems	7
1.15	slow a2091 problems	8
1.16	ide drive problems	8
1.17	scsi drive problems	8
1.18	common questions	9
1.19	tips	11
1.20	connecting vga monitors	11
1.21	video banding modification	12
1.22	processor board mounting	13
1.23	processor cooling	13
1.24	internals	14
1.25	motherboard jumpers	14
1.26	connector pin-outs	16
1.27	serial port pin-outs	17
1.28	parallel port pin-outs	18
1.29	video port pin-outs	18

1.30 keyboard port pin-outs	19
1.31 joystick port pin-outs	19
1.32 external floppy port pin-outs	20
1.33 internal floppy connector pin-outs	20
1.34 internal ide hard disk connector pin-outs	21
1.35 vga monitor pin-outs	21
1.36 power-up self-test	22
1.37 keyboard self-test	23
1.38 definitive buster	23
1.39 boards	26
1.40 68030 processor board reference	27
1.41 a2060 reference	28
1.42 a2091 reference	30
1.43 a2320 reference	31
1.44 a3640 reference	32
1.45 ariadne reference	33
1.46 emplant reference	35
1.47 oktagon reference	36
1.48 warp engine reference	38
1.49 drives	39
1.50 seagate st3144a reference	39
1.51 external scsi connector	40
1.52 scsi pin-outs	41
1.53 scsi examples	42
1.54 monitors	46
1.55 1081 reference	47
1.56 1084 reference	48
1.57 1085 reference	49
1.58 1940 reference	50
1.59 1950 reference	50
1.60 1960 reference	51
1.61 idek iiyama vision master 17 (mf-8617) reference	52
1.62 mitsubishi diamondscan aum-1381a reference	53
1.63 sources	55
1.64 altex electronics	56
1.65 chip merchant	56
1.66 dalco electronics	57
1.67 digi-key corporation	57
1.68 hosfelt electronics	57

1.69	jameco electronic components	58
1.70	jdr microdevices	58
1.71	marlin p. jones & associates	58
1.72	mcm electronics	58
1.73	memory world	59
1.74	parts express	59
1.75	redmond cable	59
1.76	editor	59
1.77	credits	60
1.78	what's new with this version	60
1.79	Index	62

Chapter 1

A4000HardwareGuide

1.1 main

Amiga 4000 Hardware Guide 3.0
compiled by Warren Block

Introduction

Drives

Common Problems

Monitors

Common Questions

Sources

Tips

Editor

Internals

Credits

Boards

Index

What's New With This Version

1.2 introduction

Introduction

Copyright

This document is Copyright © 1995 by Warren Block.

Distribution

The Amiga 4000 Hardware Guide is FreeWare. It has been copyrighted to assure its availability to all. Fred Fish and the Aminet are explicitly allowed to include this document in CD-ROM or floppy compilations. Others should contact the

Editor

.

Disclaimer

Working on computer hardware can be dangerous, both to the computer and to yourself. If you are not a qualified technician, please do not attempt to perform any of these procedures yourself. Neither myself nor any of the people listed in the

Credits

make any claim that any of these tips actually work. In fact, they will probably destroy your computer or your self-confidence. Neither is any claim made that any of the information presented here is error-free, so if you do attempt any of these modifications or fixes and damage yourself or the computer, neither myself nor any of the persons listed in the Credits section will be held responsible.

Introduction

The Amiga 4000 Hardware Guide was compiled from online messages posted by many different folks, various hints and tips I've collected elsewhere, and from my own experiences with the 4000. So it is by no means complete. Corrections or additions are welcomed.

The purpose of the guide is to help make A4000 troubleshooting easier by gathering all kinds of Amiga 4000 hardware information into a single, easy-to-use guide file.

This guide is specifically for the Amiga 4000; however, at the prompting of several other individuals, I've compiled a short A1200 hardware FAQ to address those same old questions I see popping up in c.s.a.hardware all the

time. Both are available in the hard/misc directory of Aminet.

All of the people who have contributed are listed under

Credits

. I can't

thank them enough! At this point in time, information of this type can be very valuable in keeping A4000 systems alive and running, and they have been gracious enough to freely share this information with everyone.

Comments on this document should be addressed to the

Editor

.

1.3 common problems

Common Problems

Fan Problems

Battery Problems

-5V Power Problems

Zorro-III Problems

Video Banding Problems

SCSI Reselect Problems

Green Display Problems

Dead Machine Problems

Other Video Problems

Slow A2091 Problems

Backplane Problems

IDE Drive Problems

Cable Routing Problems

SCSI Drive Problems

1.4 fan problems

Fan Problems

A4000 makes rattling noises, fan stalls on powerup, or fan does not turn. Solution: replace fan. Replacement fans: Radio Shack #273-243 or Panasonic FBK-08A12M, available from Digi-Key, Hosfelt, and others (see Sources).

Please be aware that I've seen two styles of power supplies in the 4000; the fans may differ slightly. Some older 4000s had a power supply with a large hole for the fan, and a bolt-on grill protecting it. This power supply used an actual Panasonic FBM-08A12M. A newer power supply design has a built-in grill formed by holes in the side of the power supply; in this case, the fan is held in place by four odd-looking screws that are tapped directly into the holes in the fan's plastic frame, and the fan itself is a "MAX FLOW" generic.

1.5 -5v power problems

-5V Power Problems

Problems with large hard disk transfers, discolored Toaster output (pink or magenta display of white areas), system crashes, or Emplant diagnostic failures. (See

Emplant Reference

.) Solution: U198 7905 -5V regulator is probably bad. Replace with new 7905 1-amp -5V regulator (see Sources).

To locate U198, look near the bottom expansion slot at the back of the machine.

The easiest way to replace this component may be to clip off the leads close to the body of the defective part, then trim the leads on the replacement and solder it to the old pins.

	New 7905 regulator
	(side view)
Solder	
here	

```

Old leads on motherboard      \          |
                                \          |
                                \          |
                                \          |
                                \          |
                                \          |
                                \          |
XXXXXXXXXX          |-----|          |
X                                     |-----|
X                                     |-----|
X                                     |-----|

```

1.6 video banding problems

Video Banding Problems

Display on monitor has faint, darker vertical bands or stripes. See the Tips section for the Video Banding Modification.

1.7 green display problems

Green Display Problems

Video output from the A4000 has a greenish tint. This may be caused by the Sync On Green jumper (J500) being in the wrong position. Unless the monitor is set up to receive sync signals piggybacked on the Green video input, pins 1-2 of J500 should be jumpered. See Internals/Motherboard Jumpers.

1.8 other video problems

Other Video Problems

Video problems can be caused by improperly-wired peripheral cables or malfunctioning peripherals, since some signals are shared between the video slot, video connector, and peripheral ports. Disconnect peripherals to isolate video problems to the motherboard.

1.9 backplane problems

Backplane Problems

After adding or removing expansion cards, system no longer boots, displays yellow screen. Solution: too-long resistor and capacitor leads on solder side of backplane daughterboard are bent and shorting together. Remove the backplane and trim leads.

1.10 cable routing problems

Cable Routing Problems

Make sure that signal and power cables aren't blocking the power supply fan air intake. The floppy ribbon cable can be routed from the motherboard between the power supply connector and the power supply itself. If there is only one drive installed, excess ribbon can be pushed under it.

1.11 battery problems

Battery Problems

Battery (BT176) is "furry." Batteries can actually leak and destroy part of the motherboard, so replacement of corroded batteries is advised.

Dalco
's

3.6V 3-pin battery, part #46875, is an almost-identical part: the pins and size are identical, but it is rated for 60 mAh rather than the A4000 stock battery's 40 mAh.

1.12 zorro-iii problems

Zorro-III Problems

Problems with transfers when using 4091 SCSI-2 controller or other Zorro-III boards. Check for revision of Super Buster; the revision 9 chip had problems with Zorro-III bus arbitration. Revision 11 of the Super Buster fixed this problem. Note that this problem is not due to DMA transfers, but Zorro-III bus arbitration, so it is possible to see it with any Zorro-III board.

Problems may be encountered with the
A2091

or GVP Series II SCSI controller boards. To isolate this problem, check disk transfers to Chip RAM with a program like DiskSpeed 4.2. This problem can be fixed by replacing PAL U209 on the

A3640 daughterboard with a revision 3 version.

There can be a software component to these problems, also. Check that `libs:68040.library` is at least version 37.30. Note that due to the way the library version numbers are handled, version 37.4 is an earlier version. The later 37.30 library correctly handles Zorro-III transfers and mapping of Zorro-III boards (for instance, Commodore's SCSI drivers require that copyback caching be disabled during DMA, and this version of the library does that).

1.13 scsi reselect problems

SCSI Reselect Problems

System reports "SCSI Bus Phase Error." Check that all SCSI devices support Reselect; if not, disable Reselect mode for the entire bus (how to do this varies depending on the SCSI host adapter).

1.14 dead machine problems

Dead Machine Problems

A4000 does nothing on power-up; keyboard light, power light, and hard drive spin-up show that power supply is working, but screen is gray or black, and disk drive doesn't click.

Possible cause: the processor board is not firmly connected to the mother board, or has worked its way loose (the power LED may flash quickly in this situation). Reseat the connector strip that is parallel to the floppy drive. Since this connector is quite long, it is possible for the ends to be firmly attached while the center is not making adequate contact. Be careful not to flex either board too much while reconnecting them; using a large rubber eraser or other flat object will protect your fingers while pressing the boards together gently. In extreme cases, it may be necessary to use a contact cleaner to clean accumulated gunk (like silicon heatsink compound) from the connectors.

Possible cause: the motherboard is not supported very well near the internal IDE connector. Solution: gently lift the motherboard near this connector. Installing an insulating support underneath the motherboard near here will be a more permanent solution.

Possible cause: power supply failure. A company called Micro R&D repairs

and upgrades power supplies. Contact them at:

Micro R&D
721 'O' Street
Loup City NE 68853
(308) 745-1243

1.15 slow a2091 problems

Slow A2091 Problems

A2091 SCSI controller in A4000 performs very slowly. Solution: the A2091 controller has problems with the A4000 environment (see A2091 Reference in the Boards section). Several utilities are available in the "hard" directory of Aminet that can help speed up the A2091's performance in an A4000.

1.16 ide drive problems

IDE Drive Problems

Files larger than about 128K are corrupted when copied to or from an IDE hard drive. Solution: set MaxTransfer for every partition on the hard drive to 0x0001FE00. This problem is due to the way some IDE hard drives respond to requests for large blocks of data.

Note that MaxTransfer is *NOT* "maximum transfer rate," but rather "Maximum Transfer Size."

1.17 scsi drive problems

SCSI Drive Problems

Errors occur on transfers to or from SCSI hard drives, CD-ROM drives, or other SCSI devices: Possible causes: improper termination or bad cables. See Drives/

SCSI Examples
for example SCSI configurations.

1.18 common questions

Common Questions

Memory Questions

Question: What type of memory does the A4000 use?

Answer: The A4000 comes with a single 2M SIMM installed for Chip RAM, and has four SIMM sockets for expansion memory (Fast RAM). These sockets hold 72-pin SIMMs, either 1M or 4M in capacity, 80 ns or faster. All Fast RAM SIMMs must be the same size. To fit properly, these SIMMs must be single-sided modules. (These specifications describe the motherboard memory; expansion boards may use other types of memory.)

Question: Can the A4000 use 36-bit SIMMs, instead of 32-bit?

Answer: Yes. The extra parity bits are ignored.

IDE Hard Drive Questions

Question: Can the A4000 support two IDE hard drives?

Answer: Yes, since IDE supports a master/slave drive setup. Make sure the drive jumpers are set properly for two drives.

Question: Can the A4000 use IDE hard drives larger than 512M?

Answer: Yes. The supposed "limit" of 512M is a limitation of the BIOS in MS-DOS machines, and the A4000 is not subject to this limit. The maximum supported size of a hard drive is 2G (~2000 megabytes).

Question: Can "EIDE" or "Fast ATA" hard drives be used in the A4000?

Answer: Yes. These are just revised versions of IDE, and should work fine with the A4000's on-board IDE controller.

SCSI Hard Drive Questions

Note: Many of the questions answered here are covered in much greater detail in the SCSI Examples section.

Question: Does the A4000 come with a SCSI or SCSI-2 hard drive controller?

Answer: No. The A4000T (tower) model did come with a built-in SCSI-2 controller, though. The A4091 and FastLane expansion boards are common SCSI-2 controllers for the A4000, and the A2091 is a fairly common SCSI-1 controller.

Question: Why doesn't SCSI work on the A4000?

Answer: It does. But because of a bug in early versions of the Zorro-III DMA controller (the "Buster" chip), DMA SCSI controllers didn't work properly. This problem can be fixed (by replacing the early revision 9 Buster with a revision 11 version) or avoided altogether (by using a SCSI controller that doesn't use the Zorro-III bus, like the one built into the Warp Engine accelerator).

Question: What are SCSI terminators?

Answer: Terminators are resistor packs attached at both ends of the SCSI chain. The resistance reduces ringing and noise on the bus, and is necessary for reliable operation.

Question: What is the proper setup for SCSI termination?

Answer: Both ends of the SCSI chain need to have terminators, and there should be none in the middle.

Now, the catch: some SCSI devices are not very compliant with the SCSI specification, and require oddball setups. Devices made within the last couple of years are usually pretty compliant.

Question: Can a SCSI-1 drive be used with a Fast SCSI-2 controller?

Answer: Yes, and the reverse will also work. SCSI-1 and SCSI-2 (and Fast SCSI-2) are compatible. Of course, a SCSI-1 drive won't go any faster when plugged into a Fast SCSI-2 controller; neither will a Fast SCSI-2 drive connected to a SCSI-1 controller go any faster than SCSI-1.

Question: What is the pin-out for a DB25 SCSI connector? What about the standard 50-pin SCSI header?

Answer: See the Drives/
SCSI Pin-Outs
section for both.

Question: Will SCSI hard drives meant for the Mac work on an A4000?

Answer: Yes. The cable included with most external Mac hard drives is a DB25-to-Centronics 50 adapter, and this will work on a SCSI controller with DB25 external SCSI port. Software is available for accessing an existing Mac filesystem, so file interchange with a portable SCSI device is possible.

CD-ROM Questions

Question: Will an EIDE CD-ROM drive work with the A4000's IDE interface?

Answer: Not unless you can locate a replacement for the scsi.device driver, which isn't capable of dealing with CD-ROM drives. SCSI is usually simpler to set up. Beware of pseudo-IDE CD-ROM drives, like the older Mitsumi, Panasonic, and Sony drives which will not work unless you have a special interface board for them.

1.19 tips

Tips

Connecting VGA Monitors

Video Banding Modification

Processor Board Mounting

Processor Cooling

1.20 connecting vga monitors

Connecting VGA Monitors

VGA monitors can be connected to the A4000; however, since the special circuitry in the Amiga video output can mistakenly identify a monitor as a genlock and thus cause problems, a special cable or adapter is the best way to hook them up. All this cable really does is buffer the horizontal and vertical sync signals by double-inverting them through a TTL gate. Commodore's DB23-to-HDD15 adapter (supplied with most A4000s) used a 74HCT08 for this, but you can use a 74LS04 or other low-power TTL-level inverters (or other gates wired as inverters, of course).

Remember that most VGA monitors won't sync at 15.75 kHz, so you'll have to set the A4000 to use the Double NTSC (or Double PAL) or Multiscan video modes. Even using these modes, the video output may not work with some VGA monitors, since some of the modes use horizontal sync frequencies as low as 23 kHz, and normal VGA starts at 31.5 kHz. Using the VGAOnly monitor driver will bump these frequencies up a bit, perhaps enough to make them usable with picky monitors.

A4000 VGA Video Cable

A4000 DB23

VGA HDD15

Red (Pin 3) ----- Red (Pin 1)

Green (Pin 4) ----- Green (Pin 2)

Blue (Pin 5)	-----	Blue (Pin 3)
Grounds (Pin 16-20)	-----	Grounds (Pin 5-8,10,11) and ground for inverter. Also use a .01 uF ceramic decoupling cap between +5V and ground at the chip power supply pins.
Horizontal Sync (Pin 11)	<pre> \ \ >o---- >o----- / / </pre>	Horizontal Sync (Pin 13)
Vertical Sync (Pin 12)	<pre> \ \ >o---- >o----- / / </pre>	Vertical Sync (Pin 14)
+5V (Pin 23)	-----	Power supply for inverter chip.

1.21 video banding modification

Video Banding Modification

Video Banding Modification: Many (most?) A4000s show some faint vertical bands on the display. There is a modification to prevent this, but, like anything else, it has advantages and disadvantages.

Advantages

- Removes vertical bands from display.
- Simple modification.
- Relatively easy to disable.

Disadvantages

- Interferes with operation of attached genlocks and deinterlacer boards like the Amber A2320 board (see Boards/A2320 'Amber' Reference).

The modification involves connecting pin 15 of the video port connector through a 100 ohm, 1/4 watt resistor to ground. This can be done inside the A4000, but it's safer and more versatile if the modification is performed on the DB23-to-HDD15 adapter that was included with the A4000. That way the adapter can be unplugged from the machine if a genlock or Amber board is to be used.

There are two grounds on the adapter PC board: shield ground and video ground (pins 16-20). Since all the other components on the board use the video ground, it seems reasonable to use it for this modification, rather than the more-easily-reached shield ground. The resistor fits nicely on the bottom of the adapter PC board, running from pin 15 to pin 18 of the connector's soldered pins.

1.22 processor board mounting

Processor Board Mounting

The nylon standoffs that hold the A3640 processor daughterboard in place grip the board very, very tightly, making removal difficult and prone to flexing this fragile board. Pushing the two halves of the standoff together with needle-nose pliers makes it somewhat easier to remove the processor board, but it may still be a fight, putting stress on the motherboard, the processor board, and the person removing it. After removing the board, you can clip off one "prong" of the side that plugs into the processor board. If you leave one of these prongs in place, the processor board will still be held firmly in place, but removal will be much easier, next time, anyway. If you are afraid that the processor board will not be held firmly enough, do this modification on only two of the standoffs.

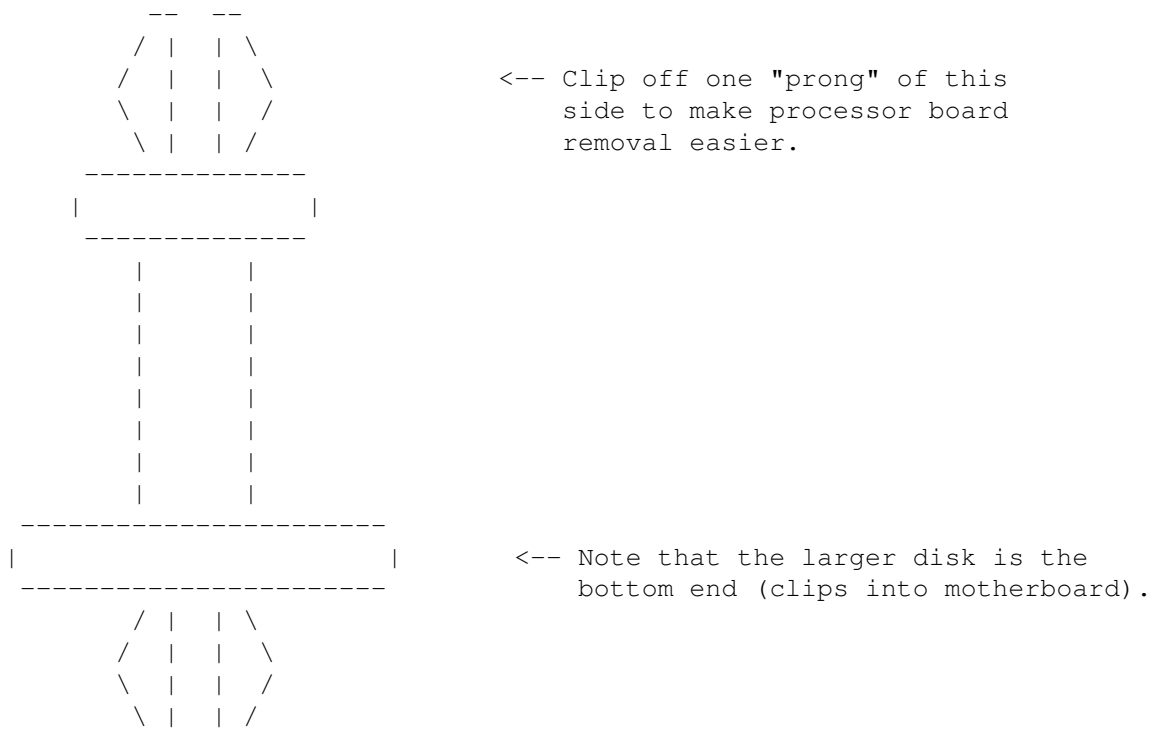

1.23 processor cooling

Processor Cooling

A company called PC Power & Cooling makes a stick-on cooling fan for the 486 and Pentium processors that just happens to fit the 68040 perfectly. The fan uses a stick-on backing to attach to the chip, so you don't have to mess with little clips or spring wires. It spins on ball bearings instead of a bushing, so life expectancy is claimed to be 50,000 hours instead of

the ordinary bushing fan's 5000 hours. A disk-drive power connector powers the fan. Finally, it's only .6 inches high, no more than the heat sink that comes with the A3640 processor board. PC Power & Cooling calls it by several names; the best one to use is the "PENTA-COOL 54" for the 90 MHz Pentium or the "CPU-COOL 1.9."

Some earlier versions of the fan had "corners" cast into the aluminum heat sink to better fit the 486; these versions don't fit the 68040 without modification, so ask for either of the versions above, or make sure they know that the one you're purchasing must be of the flat variety.

In the United States, you can usually save a few dollars by ordering these fans from large mail-order companies like PC Connection, but please make sure of the model and brand first.

PC Power & Cooling
5995 Avenida Encinas
Carlsbad CA 92008
(800) 722-6555
(619) 931-6988 Fax

1.24 internals

A4000 Internals

Motherboard Jumpers

Connector Pin-Outs

Power-Up Self-Test

Keyboard Self-Test

Definitive Buster

1.25 motherboard jumpers

Motherboard Jumpers

A4000 Motherboard

```

-----
|   ooo           || oo           |           | |
| Internal        || DF1:         |           |
| Audio          || Enable       |           |
| Connector      ||             | Power     |
|                ||             | Supply   |
|                ||             |           |
|                ||             |   ooo    |
|                ||             |   ooo    | Fan     |
|                ||             |   ooo    |-----|
|                ||             | Power    |
|                ||             | Supply   |
|                ||             | Connector|
|                ||             |           |
|                ||             |           |
|                ||             |           |
|                ||             |           |
|                ||             | Drive   |
|                ||             | Bays    |
|                || oo         |           |
|                || SIMM      |           |
|                || Size     |           |
|                ||         |           |
-----

```

Jumpers

J351: DF1 Enable

Closed: Enable low-density (880K) floppy as DF1.
 Open: No DF1 *OR* for high-density (1.76M) DF1.

J852: Fast RAM SIMM Size (Chip RAM is always 2M.)

256K: 1M SIMMs.
 1M : 4M SIMMs.

CN404: Internal Audio Connector

Audio signals attached here will be mixed with the A4000 audio output. The A4000 audio is somewhat louder than the normal line level output from most CD-ROM drives, presumably to make sound effects audible over background music. Setting the software-controlled A4000 audio level lower (to 32 instead of 64) will help match the levels.

Pin 1: Audio In (Left)
 Pin 2: Ground.
 Pin 3: Audio In (Right)

Other Jumpers (Not Shown Above)

J100: CLK90 Clock Source

1-2 Closed: Internal (68020/68030)
 2-3 Closed: External (68040)

- J104: CPU Clock Source
 1-2 Closed: Internal
 2-3 Closed: External
- J151: ROM Speed: 160 or 200 ns ROMs.
 1-2 Closed: 200 ns ROMs (default).
 2-3 Closed: 160 ns ROMs.
- J213: Chip RAM: 2M or 8M
 1-2 Closed: 2M Chip RAM (default).
 2-3 Closed: 8M Chip RAM. This option was apparently for use with the never-released AAA chip set, and won't work in a normal A4000.
- J500: Sync On Green
 1-2 Closed: Sync on green disabled (default?).
 2-3 Closed: Sync on green enabled (see the Common Problems section for the Green Display Problems note on this jumper).
- J501: Lisa Sync (Wide input on the Lisa chip.)
 1-2 Closed: CSync from Agnus Pin 80.
 2-3 Closed: +5V (default).
- J502: Select DAC Sync
 1-2 Closed: DAC syncs on green.
 2-3 Closed: DAC uses standard signal (default).
- J850: Enable DSACK (Used with 68020)
 1-2 Closed: DSACK Enabled for 68020. U860 and U152 also required.
 2-3 Closed: No DSACK.
- J975: "Options" connector. Apparently for some type of expansion, perhaps for use with mouse or joystick-type peripherals.

Power Supply Connector Wires

Yellow: +5V
 Orange: +12V
 Blue: Ground
 Red: -12V
 Brown: Power Good (???)

1.26 connector pin-outs

Connector Pin-Outs

Note: Signals shown with a star (*) in front of them are active-low. Please check the pin-out information shown here with a meter before using it.

Serial Port

Parallel Port

Video Port

Keyboard Port

Mouse/Joystick Ports

External Floppy Port

Internal Floppy Connector

Internal IDE Hard Disk Connector

VGA Monitor Pin-Outs

1.27 serial port pin-outs

Serial Port (DB25 Male)

Pin 1: Shield Ground
Pin 2: Transmit Data
Pin 3: Receive Data
Pin 4: RTS
Pin 5: CTS
Pin 6: DSR
Pin 7: Data Ground (Do not connect to shield ground.)
Pin 8: CD
Pin 9: +12V (20 mA maximum.)
Pin 10: -12V (20 mA maximum.)
Pin 11: Amiga Audio Out (Left)
Pin 12: Unused

Pin 13: Unused
Pin 14: Unused
Pin 15: Unused
Pin 16: Unused
Pin 17: Unused
Pin 18: Amiga Audio In (Right)
Pin 19: Unused
Pin 20: DTR
Pin 21: Unused
Pin 22: RI
Pin 23: Unused
Pin 24: Unused
Pin 25: Unused

1.28 parallel port pin-outs

Parallel Port (DB25 Female)

Pin 1: *Strobe
Pin 2: Data 0
Pin 3: Data 1
Pin 4: Data 2
Pin 5: Data 3
Pin 6: Data 4
Pin 7: Data 5
Pin 8: Data 6
Pin 9: Data 7
Pin 10: *Acknowledge
Pin 11: Busy
Pin 12: Paper Out
Pin 13: Select
Pin 14: +5V Pull Up (10 mA maximum.)
Pin 15: Unused
Pin 16: *Reset
Pin 17: Ground (Do not connect any of these grounds to a shield.)
Pin 18: Ground
Pin 19: Ground
Pin 20: Ground
Pin 21: Ground
Pin 22: Ground
Pin 23: Ground
Pin 24: Ground
Pin 25: Ground

1.29 video port pin-outs

Video Port (DB23 Male)

Pin 1: *External Clock
 Pin 2: *External Clock Enable (47 ohm)
 Pin 3: Red Video (75 ohm)
 Pin 4: Green Video (75 ohm)
 Pin 5: Blue Video (75 ohm)
 Pin 6: Digital Intensity (47 ohm)
 Pin 7: Digital Blue (47 ohm)
 Pin 8: Digital Green (47 ohm)
 Pin 9: Digital Red (47 ohm)
 Pin 10: *Composite Sync (47 ohm)
 Pin 11: *Horizontal Sync (47 ohm)
 Pin 12: *Vertical Sync (47 ohm)
 Pin 13: Ground Return (Digital ground return for pin 2.)
 Pin 14: *Pixel Switch (Genlock overlay, 47 ohm)
 Pin 15: *Clock Out (47 ohm)
 Pin 16: Video Ground (Do not connect any of these grounds to pin 13.)
 Pin 17: Video Ground
 Pin 18: Video Ground
 Pin 19: Video Ground
 Pin 20: Video Ground
 Pin 21: -5V (10 mA maximum.)
 Pin 22: +12V (100 mA maximum.)
 Pin 23: +5V (100 mA maximum.)

1.30 keyboard port pin-outs

Keyboard Port (6-Pin Female Mini-DIN, PS/2 Type)

Pin 1: Data		6	---	5
Pin 2: Unused	Pin Layout:			
Pin 3: Ground	(Index key			
Pin 4: +5V (100 mA maximum.)	at top.)	4	---	3
Pin 5: Clock				
Pin 6: Unused		2		1

Note: A PS/2 keyboard will not work with the A4000.

1.31 joystick port pin-outs

Mouse/Joystick Ports (DB9 Male)

Mouse:	Light Pen:
Pin 1: Mouse Vertical	Pin 1: Unused
Pin 2: Mouse Horizontal	Pin 2: Unused
Pin 3: Mouse Vertical Quadrature	Pin 3: Unused
Pin 4: Mouse Horizontal Quadrature	Pin 4: Unused
Pin 5: Mouse Button 3 (Middle)	Pin 5: Light Pen Press

Pin 6: Mouse Button 1 (Left)	Pin 6: *Light Pen (Capture Beam Pos)
Pin 7: +5V (50 mA maximum.)	Pin 7: +5V (50 mA maximum.)
Pin 8: Ground	Pin 8: Ground
Pin 9: Mouse Button 2 (Right)	Pin 9: Unused

Digital Joystick:

Pin 1: *Forward
 Pin 2: *Back
 Pin 3: *Left
 Pin 4: *Right
 Pin 5: Unused
 Pin 6: *Fire
 Pin 7: +5V (50 mA maximum.)
 Pin 8: Ground
 Pin 9: Fire Button 2

Analog (Proportional) Joystick:

Pin 1: Button 3
 Pin 2: Unused
 Pin 3: Button 1
 Pin 4: Button 2
 Pin 5: Pot X (Horizontal Control)
 Pin 6: Unused
 Pin 7: +5V (50 mA maximum.)
 Pin 8: Ground
 Pin 9: Pot Y (Vertical Control)

1.32 external floppy port pin-outs

External Floppy Port (DB23 Female)

Pin 1: *Disk Ready
 Pin 2: *Disk Read Data
 Pin 3: Ground
 Pin 4: Ground
 Pin 5: Ground
 Pin 6: Ground
 Pin 7: Ground
 Pin 8: *Disk Motor Control
 Pin 9: *Select Drive 3
 Pin 10: *Disk Reset
 Pin 11: *Disk Change (Latched Low)
 Pin 12: +5V (250 mA maximum.)
 Pin 13: *Select Disk Side (0=Upper, 1=Lower)
 Pin 14: *Write Protect
 Pin 15: *Track Zero
 Pin 16: *Disk Write Enable
 Pin 17: *Disk Write Data
 Pin 18: *Step (Pulse: Low, then high.)
 Pin 19: Direction (0=Inner, 1=Outer)
 Pin 20: Unused
 Pin 21: *Select Drive 2
 Pin 22: *Disk Index Pulse
 Pin 23: +12V (160 mA maximum, 540 mA surge.)

1.33 internal floppy connector pin-outs

Internal Floppy Connector (34-Pin Male Header)

Pin 1: Ground	Pin 18: Direction
Pin 2: *Change	Pin 19: Ground
Pin 3: Unused	Pin 20: *Step
Pin 4: *In Use 1	Pin 21: Ground
Pin 5: Ground	Pin 22: *DKWD
Pin 6: *In Use 0	Pin 23: Ground
Pin 7: Ground	Pin 24: DKWE (Write Enable?)
Pin 8: *Index	Pin 25: Ground
Pin 9: Ground	Pin 26: *TRKD
Pin 10: *Select 0	Pin 27: Ground
Pin 11: Ground	Pin 28: *Write Protect
Pin 12: *Select 1	Pin 29: Ground
Pin 13: Ground	Pin 30: *DKRD
Pin 14: Unused	Pin 31: Ground
Pin 15: Ground	Pin 32: *Side
Pin 16: *MTRI	Pin 33: Ground
Pin 17: Ground	Pin 34: *Ready

1.34 internal ide hard disk connector pin-outs

Internal IDE Hard Disk Connector (40-Pin Male Header)

Pin 1: *Reset	Pin 21: Unused
Pin 2: Ground	Pin 22: Ground
Pin 3: Drive Data 7	Pin 23: *I/O Write
Pin 4: Drive Data 8	Pin 24: Ground
Pin 5: Drive Data 6	Pin 25: *I/O Read
Pin 6: Drive Data 9	Pin 26: Ground
Pin 7: Drive Data 5	Pin 27: I/O Channel Ready
Pin 8: Drive Data 10	Pin 28: Unused
Pin 9: Drive Data 4	Pin 29: Unused
Pin 10: Drive Data 11	Pin 30: Ground
Pin 11: Drive Data 3	Pin 31: Interrupt Request
Pin 12: Drive Data 12	Pin 32: Unused
Pin 13: Drive Data 2	Pin 33: Disk Address 1
Pin 14: Drive Data 13	Pin 34: Unused
Pin 15: Drive Data 1	Pin 35: Disk Address 0
Pin 16: Drive Data 14	Pin 36: Disk Address 2
Pin 17: Drive Data 0	Pin 37: *IDE_CS1
Pin 18: Drive Data 15	Pin 38: *IDE_CS2
Pin 19: Ground	Pin 39: *Active (LED driver output.)
Pin 20: Unused	Pin 40: Ground

1.35 vga monitor pin-outs

VGA Monitor Connector (HDD15 Male)

Standard VGA or multisync monitors use a high-density 15-pin D-connector. This HDD15 connector is the same overall size as a DB9, and in fact early VGA monitors used DB9 connectors. After a while, the connector standardized on the HDD15, probably because many people were damaging their new VGA monitors by connecting them to MDA (mono) video cards.

On some cables, pin 9 is not only not connected, but not even present in the connector.

Male HDD15 VGA Connector

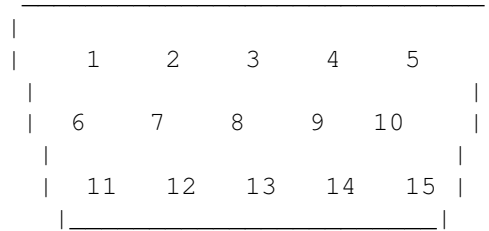

Female HDD15 VGA Connector

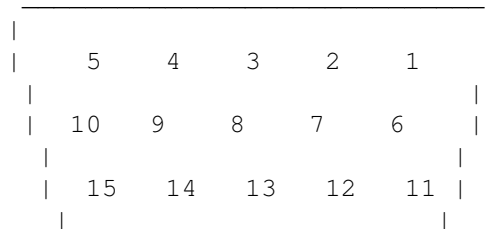

Pin 1: Red Video
 Pin 2: Green Video
 Pin 3: Blue Video
 Pin 4: Ground
 Pin 5: Unused
 Pin 6: Red Ground
 Pin 7: Green Ground
 Pin 8: Blue Ground
 Pin 9: Unused
 Pin 10: Ground
 Pin 11: Ground
 Pin 12: Unused
 Pin 13: Vertical Sync
 Pin 14: Horizontal Sync
 Pin 15: Unused

1.36 power-up self-test

Power-Up Self-Test

Test Status	Color Shown	Description Of Error
Passed	Light Gray	Initial hardware configuration tests passed. Initial software tests passed. Final

		initialization test passed.
Failed	Red	ROM Error: Make sure ROMs are seated properly.
	Green	Chip RAM Error: Make sure Agnus is seated, and check Chip RAM SIMMs for proper seating.
	Blue	This is a non-existent error color. Nobody knows where it came from...
	Yellow	Processor detected error before software trapped it.
	Purple	Not an "official" color, but may be caused by bad ROMs.

1.37 keyboard self-test

Keyboard Self-Test

Number Of Caps Lock Blinks	Description Of Error
One	Keyboard ROM failed.
Two	Keyboard RAM failed.
Three	Watchdog timer failed.
Four	Short detected in keyboard.

1.38 definitive buster

Definitive Buster

Editor's Note

The following information is a text on interactions between the various versions of Buster chip, the Zorro III bus, and the A3640 processor board, kindly provided by Dave Haynie himself.

System	Buster	RAMSEY	DMAC	CPU
A3000/16	-07	-04	-01/02	68030-16/68881-16
A3000/25	-06/07	-04	-01/02	68030-25/68882-25
A3000T/030	-07	-04	-02	68030-25/68882-25
A3000T/040	-07	-04	-02	A3640 3.0/3.1 (some have '030 too)
A3000+	-09	-07	-04	68030 (68040 planned)
A4000/030	-09/11	-07	N/A	68EC030-25
A4000/040	-09/11	-07	N/A	A3640 3.0/3.1
A4000T	-11	-07	N/A	A3640 3.2

Nyx (AAA proto) -11 -07 N/A Any CPU module

The A3640

The A3640 had two problems in its Rev 3.0 form. The first was a marginality -- its sampling of the local bus STERM* signal was marginal. This is fixed on Rev 3.1 with a cut and jumper. But beware, some boards marked 3.1 didn't get this fix, though apparently they're a small number.

The second problem on the A3640 Rev 3.0 is a real live bug. This was a flaw in the bus arbiter that could allow the '040 and any local bus master on the local bus at the same time. Rev 3.1 incorporates -02 of the U209 PAL to fix this problem. It's not a perfect solution, though, in that it creates a potential for the local bus master to be locked out of the local bus for 10's of microseconds, even if the '040 isn't using the bus. This was corrected in -03 of the U209 PAL, which makes your Rev 3.1 A3640 into a Rev 3.2 A3640. Clearly, if you're not using cards with a DMA problem, this is not an issue.

The technical detail on this is that, originally, the A3640 didn't handle a state of the 68040 bus arbitration scheme called "implied mastership". Most of the time the '040 wants the bus, it will assert either BR* (bus request) and/or BB* (bus busy); the former requests the bus, the latter holds it on the bus until it's ready to get off. However, the '040 can still claim the cycle after it negates both BB* and BR*. This is called implied mastership. The idea is that the '040 arbiter figures the current cycle will probably hit in cache, and decides to let another '040-like device on the bus one clock sooner than it might have. Other '040s understand this, and (when their arbiters are properly designed, at least) they can start taking the bus, but stop if the relinquishing '040 really isn't giving the bus back.

The Rev 3.0 A3640 didn't handle this condition at all. So the implied mastership condition, which is fairly rare, would cause the bus arbiter to give the cycle over to a pending local bus request. The Rev 3.1 version of the bus arbiter prevented this, by holding the bus in this case. The problem with that is that when it happened, the '040 would usually hit in cache, but the bus would be locked against any other DMA device until the '040 needed the bus. A big waste, though fortunately rare. This is why the GVP PhonePak fails with Rev 3.1; it requires a fairly fine grained determinism when recording from the phone, and the Rev 3.1 card, when it locked up, could be off long enough to overrun any buffering it had available on-card. I was called in to fix this, and the Rev 3.2 board is the result; it handles implied mastership properly.

Buster

Next we consider the Buster chip. The Buster in the A3000, Rev 6 or Rev 7, is a well proven design. The difference between the two is only that there was a small bug in Rev 6 that caused it to fail at 16MHz, but it works fine at 25MHz. These are what we called Level I Busters; they don't support Zorro III DMA or Quick Interrupts, and they don't attempt to translate local bus burst cycles into Zorro III burst cycles.

Starting with the unreleased Rev 8 Buster, we went to Level II, which is roughly twice the size of the Level I design. Level II Buster supports Zorro III bus arbitration, DMA, Quick Interrupts, and translation of local bus burst cycles into Zorro III "Multiple Transfer" cycles. There are two

of these parts released: Rev 9 and Rev 11.

The Rev 9 Buster has a few flaws. The primary flaw, and the main reason the part was revised, is that the Zorro III bus arbiter can jam under the right conditions. Some DMA cards, like FastLane Z3, use a workaround for this (they avoid the lockup condition), others don't, and will lock up when used with a Rev 9 Buster. There is also a potential problem with end-of-cycle synchronization in the Rev 9 part. Some Zorro III cards will demonstrate this problem, some won't. This is made worse by the STERM* sampling problem on the Rev 3.0 A3640. A final problem with Rev 9 Buster was introduced by the A4000 architecture. The integrated bus buffer, Bridgette, used in the A4000 can't quite guarantee the propagation times required by the Rev 9 Buster design (done before Bridgette was proposed). In the typical case it works fine, in the worst case some Zorro III cards will have a problem with this condition.

The Rev 9 part was the unfortunate victim of the wheels of "progress." The first problem was a changeover at CSG (Commodore Semiconductor Group) from channeled arrays to sea of gates. They had a number of screwups on these first parts (the Rev 5 or 6 RAMSEY was also affected), first some mask problems, then speed problems. About six months after I released the Buster design, I got back parts that ran at about 1/4 normal speed; during the A3000 project, we got back parts in more like one month. These problems were eventually fixed, just in time to suffer the change in engineering administration. I had a test bed project to prove all of the features of the Buster Level II chip, a multiprocessor board called Gemini, with two '030s, 4MB of RAM and an independent Zorro III hookup each. I had a prototype of this around the time of the slow Rev 9 Busters, but when the new administration took over, they wouldn't hear of any "Research Projects." Or projects, for that matter; they also tabled the AA project for 6 months, and killed the A3000+. But that's another story...

Anyway, after the Rev 9 problems were discovered, I got to fix them, with the Rev 11 Buster. The Zorro III bus arbiter is fixed. All synchronization problems were fixed, and Rev 11 uses a double-strength driver on its STERM* line. Because of this, Rev 11 sometimes cures non-DMA Zorro III problems seen with the Rev 3.0 A3640 card -- that card's flawed STERM* sampling is right on the hairy edge, and the stronger driver makes Buster's STERM* fast enough, at least potentially, to avoid this problem. I still recommend upgrading to Rev 3.1, though, since it fixes the DMA problem, and the STERM* sampling may still be a problem in worst-case, or when RAMSEY or Gary drive STERM*. The bus buffer controls on Rev 11 Buster have been adjusted to support the A4000's buffering scheme perfectly; no properly designed Zorro III cards will have a data setup problem with Rev 11. This is especially critical for burst write cycles.

Since it was the last chip of the A3000 architecture that we could revise, I figured a way to solve another A3000 problem in the Rev 11 Buster. There's a race condition between the end of a Zorro II DMA cycle, Gary, and the Amiga chips. When lost, you have problems with Zorro II devices reading Chip RAM during DMA. This was solved with external logic on the A4000 series, and in Rev 11 I figured a way that Buster could play essentially the same trick on Gary. So Rev 11 Busters are a fix for Zorro II DMA problems on an A3000, but aren't needed for that alone on the A4000.

Still Having Problems

So maybe you're still having problems with Zorro III cards on the A4000, even with Rev 11 Buster and Rev 3.1 or 3.2 A3640, eh? I can think of a few things, though most would lie with the card design. The Rev 11 part runs a somewhat faster Zorro III cycle than Rev 7 did. This isn't a problem if the card was designed to the Zorro III spec; the A3000 architecture only allowed Zorro III to go at about 1/2 its potential rate. It might be a problem for any card designed more to "observed behavior," as defined by how an A3000 first behaved when released. Some cards may have a problem supporting burst cycles on Zorro III, since they couldn't be tested with the Rev 7 Buster. However, this is rare, since the only stock system from Commodore that could run burst on Zorro III is the A4000/030. That's because the A3000's Buster didn't translate burst cycles from the local bus, and the A3640 card doesn't translate burst cycles to the local bus. Also, most Zorro III cards identify themselves as "essentially I/O." These will get mapped as noncachable by the 68040.library, which means they don't get burst, even if you have an '040 card that bursts. On an '030, data burst is disabled by default (you can set it with a SetCPU-like tool), and no I/O card lives in instruction space, so still, no burst.

A final Zorro III problem exists on some cards, including the A4091s from Commodore, though not necessarily DKB (eg, I don't know). Originally, there were a couple of ways for a Zorro III card to terminate a bus cycle. It could give the bus back during its last cycle or after its last cycle. This former mechanism can cause some problems, including bus lockups, when multiple masters are present. So I only recommend the latter mechanism -- the card runs its last cycle, then unregisters the bus. This takes longer, but it's safe. This is only an issue when multiple bus mastering Zorro cards are working together.

1.39 boards

A4000 Boards

68020/68030 Processor Board Reference

A2060 Reference

A2091 Reference

A2320 'Amber' Reference

A3640 Reference

Ariadne Reference

Emplant Reference

Oktagon Reference

Warp Engine Reference

1.40 68030 processor board reference

68020/68030 Processor Board Reference

This processor board is the board supplied with the A4000/030. It may contain a 68030, 68EC030 (functionally equivalent to the 68030 but without a memory management unit), or even a 68020 processor. The 68020 option was apparently for an extremely low-cost version of the A4000; it is unlikely that any boards using the 68020 were ever sold.

A possible cost-reduced variation of this processor board has no jumpers. This type of board has a PLCC socket for the math coprocessor, which runs at the same speed as the processor.

(See also Tips/
Processor Board Mounting
.)

Jumpers

J100: FPU Select

1-2 Closed: Use FPU in the PLCC socket.

2-3 Closed: Use FPU in the PGA socket.

J101: FPU Clock

1-2 Closed: Use optional on-board oscillator at U103 for FPU clock.

2-3 Closed: Use CPU clock as FPU clock.

J103: MAPROM Enable

1-2 Closed: MAPROM disabled.

2-3 Closed: MAPROM enabled (requires U100).

J201: 68020 Select

1-2 Closed: 68020 not selected.

2-3 Closed: 68020 selected.

J202: 68030 Select

1-2 Closed: 68030 selected.
2-3 Closed: 68030 not selected.

J203: 68020/68030 Select
1-2 Closed: 68030 selected.
2-3 Closed: 68020 selected.

1.41 a2060 reference

A2060 Reference

The A2060 is a full-length Zorro-II network card that supports the Arcnet standard. While Ethernet is far more popular, Arcnet has recently become very cheap on the Amiga due to a surplus of these cards.

While Arcnet does not transfer information as quickly as Ethernet, tests of actual transfers on the Amiga suggest that it can move information at rates up to 150K bytes per second, which is adequate for many purposes. Arcnet can be configured in a bus arrangement where each machine is linked to the next, or in a star, where all the machines are connected to an active hub. The A2060 will work with both setups.

The A2060 has some bugs. First, the "hybrid" chip that forms the electronic interface to the Arcnet network comes in two different versions: HCY 9058 (for bus networks) and HCY 9068 (for star networks). As the A2060 manual describes it, the board is for a bus network, but many A2060s come with the 9068 (star) hybrid installed. A bus network needs 93-ohm terminators at each end, and this works fine with the 9058 (bus) version of the hybrid. With the 9068, however, the hybrid itself performs the termination. To connect two machines with 9068 hybrids, run coax from one machine to the other, without using terminators. Using T-connectors to attach more machines in the middle of the bus may or may not work, due to each one adding its termination to the bus. To connect a 9068-version A2060 to a bus network of 9058-version A2060s, place it at the end of the chain and connect the cable directly, without a terminator (this may limit the network to only being operational when the 9068-equipped machine is on). Both versions of the card should have no problems when attached directly to an active hub. It is also possible to replace the HCY 9068 hybrid with the 9058 version, provided you can locate one.

There are also several well-known problems with version 37.2 of the "a2060.device" driver software. Replacements for this driver are available in the comm/net directory of Aminet. Some commercial networking packages like Envoy 2.0 also include much better replacement drivers.

Other Notes

Arcnet requires RG62 coaxial cable, *not* the RG58 that Ethernet uses, and has a minimum cable length between stations of three feet (0.9 meter). Active hubs used for a star layout are self-terminating, so cables are connected directly between the hub and the Arcnet cards.

If the A2060 does not perform reliably even with updated driver software,

check the board for cold solder joints on hand-soldered components like the BNC coax connector and DIP switches. Some or all of these components may need to have overly-long leads trimmed to prevent interference with adjacent cards or connectors.

Finally, the Arcnet address switches on the back of the board are labelled incorrectly in the manual (or on the board, depending on how you look at it). At least some A2060's have a sticker stuck onto the DIP switch, which may disagree with both other references. Ignore all of these: the correct layout is described in the Switches section below. (Assign Arcnet ID numbers starting with 254 and decreasing from there. This will provide a slight performance increase due to Arcnet's token-passing setup.)

Despite all the problems, the A2060 works quite well once the bugs are corrected.

Board Layout

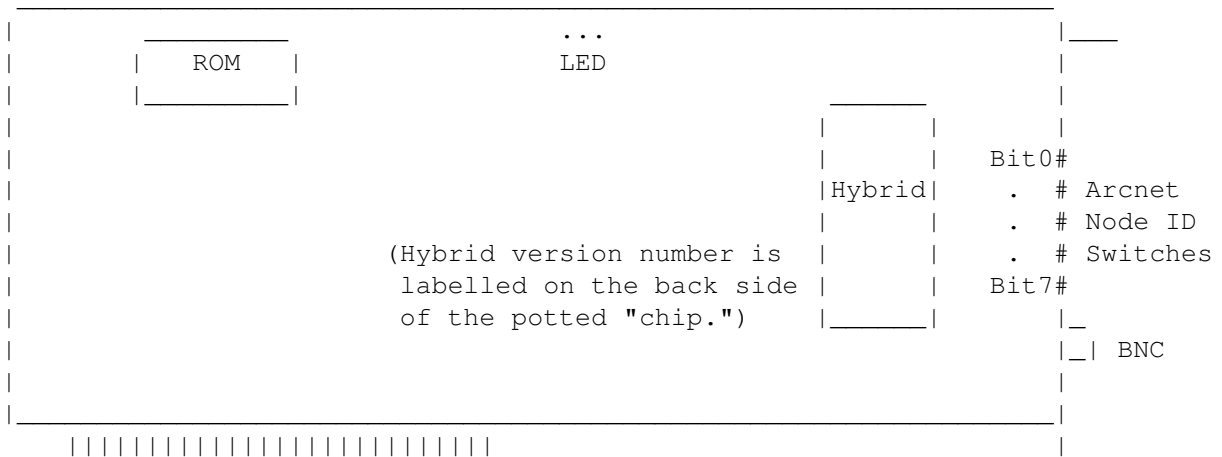

Jumpers

LED: Access LED. Attach a hard disk access LED here to see activity on the Arcnet bus. The left pin of the connector is positive, and the board provides a current-limiting resistor.

Switches

Arcnet Node ID: This switch is used to set the Arcnet address of the board (refer to the board diagram above). Bit 0 is the switch farthest from the BNC connector; bit 7 is the closest to the BNC connector.

Switch settings:

- 1: Down (toward the solder side of the board)
0: Up (toward the component side of the board)

Note: Zero is reserved, and not a valid Arcnet address.

Example Arcnet Node Address Settings

Table with 10 columns: ID, Binary, Bit7, Bit6, Bit5, Bit4, Bit3, Bit2, Bit1, Bit0. Each column has a dashed line underneath.

254	11111110	down	down	down	down	down	down	down	down	up
253	11111101	down	down	down	down	down	down	down	up	down
252	11111100	down	down	down	down	down	down	down	up	up
128	10000000	down	up	up	up	up	up	up	up	up
3	00000011	up	up	up	up	up	up	up	down	down
2	00000010	up	up	up	up	up	up	up	down	up
1	00000001	up	up	up	up	up	up	up	up	down

1.42 a2091 reference

A2091 Reference

The A2091 is a full-length Zorro-II DMA SCSI hard drive controller that was originally introduced with the A2000HD. Because of the A2091's high availability, it is often found in A4000s, even though it performs very slowly in them. The A2091 apparently can't use DMA to transfer data to 32-bit Fast RAM, and tries to use a very small buffer in Chip RAM. If this buffer can't be reached by Zorro-II DMA, the driver falls back to programmed I/O transfers. In either case, this makes for extremely slow disk transfers (approximately 1M/second and 400K/second, best case, respectively). There are utilities in the "hard" directory of Aminet that may help alleviate this problem.

ROM revisions are a common problem with the A2091; 6.6 or later ROMs are recommended, with 7.0 being the last version known. Most A2091s have revision 04 of the Western Digital 33C93 SCSI controller chip; replacing this with the 08 version may clear up SCSI bus problems.

Sixteen sockets allow for the addition of up to 2M of 16-bit Fast RAM, using CMOS 256K x 4 DRAMs (44C256) rated at 120 ns or faster. (This is not normally very useful on the A4000, since a SIMM added to the motherboard RAM sockets is simpler to obtain and install, and will operate *much* more quickly.)

Usually looked on as a cheap (sometimes very cheap) way to access SCSI peripherals from the A4000, the A2091 is certainly better than no SCSI controller at all.

A little-known and mostly-unused function of the A2091 is a built-in XT-IDE controller. The IDE connector and LED are not installed, but visible on the board to the left and upper-right of the SCSI chip. Unfortunately, this port will only work with 8-bit (XT) IDE hard drives, not the common 16-bit AT-IDE hard drives.

Board Layout

```
| DRAM _____ ::Memory ... |_____| | | | | | |
| |||| | Odd ROM | ::Size LED |
| |||| |_____|| :: |
| _____ :: :: |#
| |||| |Even ROM | :: :: 50-Pin SCSI |# External
| |||| |_____|| Options:: Connector |# SCSI
| _____ :: |# Port
| |||| :: |# (DB25)
| |||| :: |#
| _____ :: |
| |||| . Power | | | | | | | | | | | | | | | | | | |
| |||| : Connector |
|_____||
| |||||||||||||||||||||||
```

Jumpers

JP1: Memory Size

- 0K: Set for no memory.
- 512K: Set for 512K of RAM.
- 1M: Set for 1M of RAM.
- 2M: Set for 2M of RAM.

JP2: Autoboot Enable

- AUTO: Set to enable autobooting from the A2091.
- DIS: Set to disable autobooting from the A2091.

JP3: Interrupt Select

- INT6: Select interrupt 6.
- INT2: Select interrupt 2.

JP5: Options

- Option 1: LUN Enable. When jumpered, enables scanning for Logical Unit Numbers numbers at each physical SCSI address. Default value: Off.
- Option 2: Time-Out Length. When jumpered, enables longer time-out for slow-starting drives. Default: Off. (Note: When on, this jumper disables parity during the message in phase.)
- Option 3: Reserved. Factory default: Off.

JP201: Factory use only.

For pin-out information on the internal 50-pin header and external DB25 SCSI connectors, see Drives/
SCSI Pin-Outs

1.43 a2320 reference

A2320 'Amber' Reference

The A2320 is a video deinterlacer board originally built for the A2000. It is essentially the motherboard deinterlacer circuitry from the A3000 on a

board. Based on the Amber chip used in the A3000, the board is often referred to as the Amber board. Physically, the board is designed to fit into the video slot of an A2000. Electronically, it works fine in an A4000.

Why would you need a separate deinterlacer board when the A4000 already has AGA circuitry that can scan-double? If you have a VGA or multisync monitor, there are two main reasons:

- A. Not all programs can be mode-promoted to "double" screens through software (games, for instance). The Amber board will scan-double all 15.75 kHz screens.
- B. The AGA "double" modes are not truly double in frequency. A 640x200 "doubled" screen syncs at about 27.5 kHz, not the 31.5 kHz that you'd expect. Some multisync monitors can't sync this low. With an Amber board, the output is 31.5 kHz, the same as "stock" VGA.

Physical Mounting

A modified "slot cover" can be attached to the back panel of the Amber board to allow it to be attached securely to an A4000 slot. You'll also need to trim a bit off the "top" of the Amber's metal panel to allow clearance for the A4000 case (a nibbling tool is useful here). The board will only fill part of A4000 video slot; it looks funny this way, but it works.

Don't remove the enable/disable switch! The Amber gets confused by some of the "doubled" screen modes, and rather than passing them through, tries to double them to 55 kHz or above! On these modes, you'll need the disable switch to force the board to pass the video through. (Productivity mode is passed through correctly, since it was part of the ECS chip set that was around when the Amber board first came out.)

Disadvantages

The Amber board was designed before AGA came out, and doesn't really understand AGA. As noted above, some modes are not passed through properly unless the board is disabled with the switch. Also, I believe that AGA screens with more than 32 colors or HAM-6 will have the colors quantized to a certain degree. This hasn't been a problem so far, although it can be seen on things like ImageFX preview screens. Games that use the AGA color abilities but don't allow for promoting their screens to doubled modes are the only likely sources for this trouble.

1.44 a3640 reference

A3640 Reference

The A3640 is the stock 68040 processor board that comes with most A4000s. It contains a 25 MHz 68040; some boards came with the 68LC040, which is a 68040 with no built-in math coprocessor functions. The A4000 User's Guide has instructions on upgrading from a 68EC040, which has no math coprocessor or memory management unit (if any A4000s were ever shipped with 68EC040 processors, there were very few of them). Some A3640 boards (notably,

revision 3.1 boards with U209 marked as "-02" or "-03") can be used in A3000 or A3000 tower computers. (For more information on A3640 board revisions and bugs, see Internals/Definitive Buster.)

(See also Tips/Processor Board Mounting.)

Jumpers

J100: Enable *CacheDisable *MMU Disable
 1-2 Closed and 3-4 Closed: Enable CDIS* MDIS* (caches and MMU disabled at powerup and reset: default).

J400: Enable MAPROM: Enable remapping circuit for loading Kickstart into Fast RAM with a developer utility program.
 1-2 Closed: MAPROM enabled (default).
 3-4 Closed: MAPROM disabled.

1.45 ariadne reference

Ariadne Reference

The Ariadne is a combination Ethernet and parallel port board. Physically, it is a 3/4 length card, with BNC and RJ45 connectors for 10BASE-2 and 10BASE-T Ethernet connections, and a female DB25 parallel port connector.

An internal 26-pin header provides a connection for a second parallel port, and four LEDs display connection information.

By default, the Ariadne auto-selects the type of Ethernet media based on what is attached. This can be overridden by setting an environment variable called Sana2/ariadne0.config to the preferred value (10BASET or 10BASE2). For example, to force the Ariadne to use the 10BASE-T connection:

```
setenv Sana2/ariadne0.config 10BASET
```

Remember that environment variables will only be saved if they are copied to the ENVARC: logical device.

The Ariadne software claims to support up to ten Ariadne boards in one Amiga (although which Amiga has this many slots remains unclear). Software is also provided to redirect printing to the Ariadne parallel ports.

Board Layout

		Parallel Port 2	1234	1	_____	_____
		#####	0000	:::		
	JP1 ..	1	LEDs	LED	EPROM	#
	Boot		Connector			# DB25



Jumpers

JP1: Enable Boot ROM?

Off: Set to disable autobooting (default).

On: Set to enable autobooting from an on-board EPROM.

Connectors

LED Connector (6-pin header)

Pin 1: (LED 1) Twisted pair MAU link status

Pin 2: (LED 2) Transmit status

Pin 3: +5V

Pin 4: (LED 3) Collision

Pin 5: +5V

Pin 6: (LED 4) Receive status

Parallel Port 2 (26-pin header)

Note that these connections are set up for use of a standard 26-pin header to a DB25 female mounted on a slot cover. This should be a standard part, but check connections before using it.

Pin 1: *Strobe

Pin 2: +5V Pull Up (Current limit unknown on Ariadne, normally 10 mA.)

Pin 3: Data 0

Pin 4: Unused

Pin 5: Data 1

Pin 6: *Reset

Pin 7: Data 2

Pin 8: Ground (Do not connect any of these grounds to a shield.)

Pin 9: Data 3

Pin 10: Ground

Pin 11: Data 4

Pin 12: Ground

Pin 13: Data 5

Pin 14: Ground

Pin 15: Data 6

Pin 16: Ground

Pin 17: Data 7

Pin 18: Ground

Pin 19: *Acknowledge

Pin 20: Ground

Pin 21: Busy

Pin 22: Ground

Pin 23: Paper Out

Pin 24: Ground

Pin 25: Select

Pin 26: Unused

Parallel Port 1 (DB25 Female)
Parallel Port 2 (DB25 Female when connected)
Both Ariadne parallel ports have the same pin-out as the standard A4000 parallel port. See Connector Pin-Outs/
Parallel Port Pin-Outs
.

1.46 emplant reference

Emplant Reference

The Emplant is a Zorro-II board that, in combination with the appropriate software, makes it possible to emulate other computers on the Amiga system.

The Emplant hardware performs several functions. Sockets are provided for both DIP- and SIMM-packaged ROMs (the ROMs of the "target" computer are installed on the board, then copied to image files, then removed). Also provided are two Macintosh-type serial ports and a basic, no-frills, non-autobooting SCSI-1 interface based on the 53C80 SCSI chip.

Dual serial ports and the SCSI controller are optional, and some models of the board come without one or both of these options.

A "RsrvMem" command added to the the beginning of the startup-sequence sets up the MMU for use with the Emplant board. If you wish to remove the Emplant from the A4000, it's best to remove this command first, or getting the machine to start may be impossible.

Early versions of the board came with "ST" brand serial chips, "LOGIC" brand SCSI chips, or custom GALs with date codes earlier than 4693. All of these chips caused problems; the serial and SCSI chips with their respective ports, the GAL chips with general operation. Utilities Unlimited has offered free replacements for these problem chips in the past. Contact them at:

Utilities Unlimited International, Inc.
790 N. Lake Havasu Avenue #16
Lake Havasu City AZ 86403
(602) 680-9004 Sales
(602) 453-6407 Fax
(602) 680-9234 Tech Support

A commonly-defective -5V regulator on the A4000 motherboard can cause the Emplant board to fail diagnostic tests and not perform properly in other ways, including unreliable operation of AppleTalk devices. See the Common Problems section on

-5V Power Problems
for more information.

Board Layout

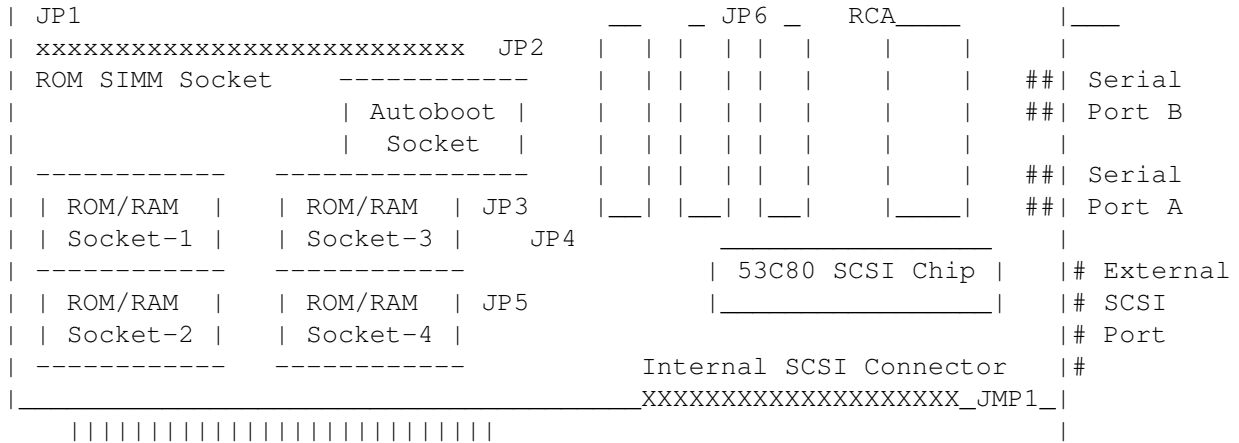

Jumpers

- JP1: ROM SIMM Address Line Selection
Right: Default.
Left: ???.

- JP2: ROM SIMM Write Enable
Right: Default (gated write select).
Left: Signal pulled up to +5V.

- JP3: Auto-Boot ROM/SRAM Socket Power/Address Select
Upper: Supply power to 28-pin DIP.
Lower: Supply address line for 32-pin DIP.

- JP4: ROM/RAM Socket 3/4 ROM/SRAM Socket Power/Address Select
Upper: Supply power to 28-pin DIP.
Lower: Supply address line for 32-pin DIP.

- JP5: ROM/RAM Socket 1/2 ROM/SRAM Socket Power/Address Select
Upper: Supply power to 28-pin DIP.
Lower: Supply address line for 32-pin DIP.

- JP6: Mac Emulation Audio Mode Select
Upper: Mono.
Lower: Stereo.

- JMP1: SCSI Terminator Power Enable
On: Supply SCSI terminator power.
Off: Do not supply SCSI terminator power.

- RCA: Input Connector For Audio Digitizing Circuitry

1.47 oktagon reference

Oktagon Reference

The Oktagon 2008S is a combination SCSI and 16-bit RAM board, much like the

A2091

. However, the Oktagon in combination with the A4000 does not have ↔ the extremely slow transfers of the A2091 (see Slow A2091 Problems .

The Oktagon uses 1Mx4 ZIP chips, either static column or page mode, to provide 16-bit RAM. An IDE version of the board is available (2008AT).

Oktagon ROM versions of less than 6.5 may have problems with removable media devices. The recommended (current) version is 6.8. To see the current ROM version number, press F1 during powerup, or use C:Version on oktagon.device.

Board Layout

Jumper			
:	:::::	:: SCSI	
LED	123456	:: Connector	
		::	#
:::::	63,83	::	# External
:::::	23,43	::	# SCSI
:::::	62,82	::	# Port
:::::	22,42	::	# (DB25)
:::::	61,81	::	#
:::::	21,41	::	
:::::	60,80	.	
:::::	20,40	: Power	

|||||

Jumpers

- 1: SCSI Enable/Disable (Open: SCSI enabled, Closed: SCSI disabled)
(On the IDE version, this enables or disables the IDE port.)
- 2: Memory Enable/Disable (Open: Memory enabled, Closed: Memory disabled)
- 3: MS0 (see below)
- 4: MS1 (see below)
- 5: Test Mem (Open: Autoconfig, Closed: Don't autoconfig)
- 6: Terminator Power (Open: None, Closed: Supply +5V SCSI term power)

Memory Size Configuration

Memory Size	MS0	MS1	Chips Added To Sockets
2M	Open	Open	20,21,22,23
4M	Closed	Open	40,41,42,43
6M	Open	Closed	60,61,62,63
8M	Closed	Closed	80,81,82,83

1.48 warp engine reference

Warp Engine Reference

The Warp Engine is a popular 68040 processor board that replaces the A3640. It includes four 72-pin SIMM sockets and a Fast SCSI-2 host adapter.

Memory: Any combination of 4M, 8M, 16M, or 32M 72-pin SIMMs, either 32-bit or 36-bit wide. Add them starting with SIMM4 and working down to SIMM1. It is advised that you put your largest SIMM in the SIMM4 socket.

SIMM Speed: For a 28 MHz Warp Engine, 80 ns SIMMs are adequate. A 33 MHz Warp Engine requires 70 ns SIMMs, while a 40 MHz board needs 60 ns.

SIMM Types: Single or double-sided SIMMs will work, although the double-sided 16M SIMM is not recommended due to high power consumption. (This probably also applies to double-sided 32M SIMMs; the Warp Engine manual doesn't say so, perhaps because they are rare at present.)

Upgrading: All that is required to convert a 28 MHz Warp Engine into a 33 MHz or 40 MHz Warp Engine is to replace the oscillator and processor (although slow memory SIMMs may require jumpering jumper D to enable a wait state). On some variations of the Warp Engine, the 68040 is soldered in place, making upgrades difficult at best.

(See also Tips/
Processor Board Mounting
.)

Jumpers

JP1: SCSI Termination Power

JP2:

A:	Mode Select	(Off: 68040 enabled, On: 68040 disabled)
B:	SIMM Type	(Off: double-sided, On: single-sided)
C:	SIMM Bank Size	(Off: 16M, On: 4M)
D:	Wait State	(Off: no wait state, On: 1 wait state)
E:	reserved	
F:	MMU Disable	(Off: MMU enabled, On: MMU disabled)
G:	Cache Disable	(Off: caches enabled, On: caches disabled)
H:	SCSI Config	(see below)
J:	SCSI Config	(see below)
K:	SCSI Config	(see below)

JP3: reserved

JP4: used for A3000 version *only* (connects to pin 21 of U350)

SCSI Configuration Jumpers (H, J, K on JP2)

K	J	H	(0=Open, 1=Closed)
-	-	-	

0	0	0	SCSI autoboot disabled
0	0	1	10-second delay, LUN scan, not synchronous
0	1	0	10-second delay, LUN scan, 200 ns synchronous
0	1	1	10-second delay, LUN scan, 100 ns synchronous
1	0	0	no delay, LUN scan, 200 ns synchronous
1	0	1	no delay, LUN scan, 100 ns synchronous
1	1	0	no delay, no LUN scan, 200 ns synchronous
1	1	1	(default) no delay, no LUN scan, 100 ns synchronous

1.49 drives

Drives

Seagate ST3096A/ST3120A/ST3144A Reference

External SCSI Connector

SCSI Pin-Outs

SCSI Examples

1.50 seagate st3144a reference

Seagate ST3096A/ST3120A/ST3144A 120M IDE Hard Drive Reference

The Seagate ST3096A (80M), ST3120A (100M), and ST3144A (120M) are the stock drives included with most A4000s.

Jumpers

	1	3	5	7	9

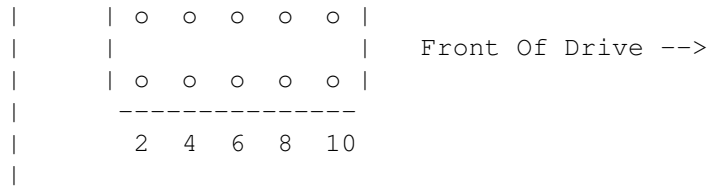

Single drive: Pins 3-4 jumpered.
Two-drive master: Pins 3-4 jumpered and pins 5-6 jumpered.
Two-drive slave: Pins 3-4 open and pins 5-6 open.
LED connected: Pins 9-10 must be jumpered to connect to an activity LED on the controller. Without this jumper, the drive will work, but there will be no activity light (unless you connect an LED to the connector on the front of the drive itself).

1.51 external scsi connector

Building An External SCSI Connector

Pin connections for external SCSI-2 half-pitch connector:

```

NOTE: Connector is VIEWED |\\\\\\\\\\\\\\\\\\\\\\\\\\\\\\\\\\\\\\\\\\\\|
FROM THE BACK, or inside | 1                               49 |
of the computer. All odd- | ----- |
numbered wires go to the | \                               / |
top of the connector, and | ----- |
all even-numbered wires go | 2                               50 |
to the bottom.           |\\\\\\\\\\\\\\\\\\\\\\\\\\\\\\\\\\\\\\\\\\\\|

```

Procedure: obtain the connector from
Redmond Cable
. Split the 50-pin SCSI

ribbon cable connectors back a couple of inches. Start with pin 1, lay it in the crimp-on pins at the upper left of the connector (again, viewed from the back of the connector). By placing the two sides of a small pair of needle-nose pliers on the wire on either side of the crimp pins, you can gently force the wire down into the V-shaped gap between them. Locate wire #2, then use the same procedure to connect it to the other side of the connector. Repeat for all 50 wires, then clip the plastic retaining clips onto the connector and give it a final squeeze to make sure all wires are making contact.

You can cut a hole in the A4000's "Expansion" port cover on the back of the machine to hold this new connector (a "nibbling" tool works well for this).

Don't forget proper SCSI termination: the devices at both ends of the chain should be terminated. If the internal SCSI cable leads from the controller to an internal drive, and then to this connector, the internal drive must be unterminated for this port to be functional. When used in this configuration, the external device plugged into this port needs to be terminated. Half-pitch terminators are available from

Dalco
 ; using one of
 these would allow you to operate the A4000 with or without an external SCSI
 device without having to open up the computer to change termination.

1.52 scsi pin-outs

SCSI Pin-Outs

Internal SCSI Port (50-Pin Header)

All odd pins are grounds, except for pin 25, which is unused.

Pin 2: *Data 0
 Pin 4: *Data 1
 Pin 6: *Data 2
 Pin 8: *Data 3
 Pin 10: *Data 4
 Pin 12: *Data 5
 Pin 14: *Data 6
 Pin 16: *Data 7
 Pin 18: *Parity
 Pin 20: Ground
 Pin 22: Ground
 Pin 24: Ground
 Pin 26: Terminator Power
 Pin 28: Ground
 Pin 30: Ground
 Pin 32: *ATN
 Pin 34: Ground (Unused?)
 Pin 36: *BSY
 Pin 38: *ACK
 Pin 40: *RST
 Pin 42: *MSG
 Pin 44: *SEL
 Pin 46: *C/D
 Pin 48: *REQ
 Pin 50: *I/O

External SCSI Connector (DB25 Female Pseudo-SCSI)

Pin 1: *REQ
 Pin 2: *MSG
 Pin 3: *I/O
 Pin 4: *RST
 Pin 5: *ACK
 Pin 6: *BSY
 Pin 7: Ground
 Pin 8: *Data 0
 Pin 9: Ground
 Pin 10: *Data 3
 Pin 11: *Data 5
 Pin 12: *Data 6

Pin 13: *Data 7
Pin 14: Ground
Pin 15: *C/D
Pin 16: Ground
Pin 17: *ATN
Pin 18: Ground
Pin 19: *SEL
Pin 20: *Parity
Pin 21: *Data 1
Pin 22: *Data 2
Pin 23: *Data 4
Pin 24: Ground
Pin 25: Terminator Power

External SCSI Connector (Centronics 50-Pin Female)

Pins 1-12 and 14-25 are grounds.

Pin 26: *Data 0
Pin 27: *Data 1
Pin 28: *Data 2
Pin 29: *Data 3
Pin 30: *Data 4
Pin 31: *Data 5
Pin 32: *Data 6
Pin 33: *Data 7
Pin 34: *Parity
Pin 35: Ground
Pin 36: Ground
Pin 37: Ground
Pin 38: Terminator Power
Pin 39: Ground
Pin 40: Ground
Pin 41: *ATN
Pin 42: Ground (Unused?)
Pin 43: *BSY
Pin 44: *ACK
Pin 45: *RST
Pin 46: *MSG
Pin 47: *SEL
Pin 48: *C/D
Pin 49: *REQ
Pin 50: *I/O

1.53 scsi examples

SCSI Examples

It seems that the SCSI bus is one of the most misunderstood aspects of connecting hard drives and other peripherals to the A4000 (or, for that matter, any other Amiga model). This section of the guide is an attempt to provide some simple examples of proper SCSI device connections. Please note that in the following section, and in the Guide as a whole, I have used the

common term "controller" when referring to disk adapter boards, although the more accurate description for both SCSI and IDE would be "host adapter."

Definitions

Since understanding SCSI requires a background in the jargon, a few basic definitions might be helpful:

SCSI

This is the original standard, now also known as SCSI-1. The maximum theoretical transfer rate is 5 megabytes per second, although most combinations of drives and controllers do much less, usually less than two megabytes per second. Total length of the SCSI bus cannot exceed six meters.

SCSI-2

An extension of the SCSI command set. Most CD-ROM drives that are double-speed or faster are SCSI-2. Note that contrary to popular belief, this doesn't go any faster than good old SCSI.

Fast SCSI-2

Here's where the speed was increased. Fast SCSI-2 has a maximum transfer rate of 10 megabytes per second, synchronous. Again, this is theoretical, and anything more than a third of that should be considered excellent.

Wide SCSI And Differential SCSI

SCSI transfers data over an 8-bit wide data path. A variation called Wide SCSI uses a 16-bit wide data path, potentially doubling transfer rates. Another variation is differential SCSI, which uses differential signal cables to provide a total bus length of up to 25 meters. Neither of these variations will be described in any detail here, since there don't seem to be any Amiga implementations of controllers for them.

Termination

SCSI bus systems require an impedance-matching terminator circuit at each end of the bus for reliable operation. Termination seems complex, but the subject can be simplified a great deal by remembering one simple rule: the SCSI bus needs to be terminated at both ends, and *only* at the ends.

The most common mistake in SCSI termination is assuming that the SCSI controller itself doesn't count; in fact, it does count as a device, and the termination rules apply to it just like other devices. Many Amiga controllers have the termination resistors soldered into place, under the assumption that only internal SCSI devices will be attached. If both internal and external devices are to be used, it is necessary to remove these resistors. SIP sockets may be soldered in their place to provide the greatest versatility, or you can just use external terminators.

Terminating resistors are usually SIP resistor packs; most are black, yellow, or blue, and there may be one, two, or three of them. External terminators look like a connector with no cable attached, and can be found

in Centronics 50-pin, DB25, and high-density 50 configurations. Some devices (notably, many external CD-ROM drives) have a termination switch.

All of the termination schemes described so far are known as "passive" terminators. Electronically, they connect each signal pin to +5V through a 220 ohm resistor, and to ground through a 330 ohm resistor. This voltage divider circuit provides impedance matching for the SCSI bus.

The alternative to a passive terminator is an "active" terminator, which connects each of the SCSI signal pins through a 110 ohm resistor to a precision +2.85V regulator (an LT1086CT, for example) which is powered by +5V. Active terminators are superior to passive terminators simply because they are active; unlike the fixed resistors in a passive terminator, the active terminator's voltage regulator will track varying voltages and properly terminate the SCSI bus. Active terminators can cure many problems with unreliable SCSI devices; their only disadvantage is that they cost a bit more (

Dalco

sells them for between thirty and forty dollars). Active termination chips are made by Dallas Semiconductor and Texas Instruments.

Any combination of passive and active terminators may be used, although two active terminators would be best. In practice, passive/passive or passive/active are usually adequate.

Termination Power

Terminator power (+5V) is supposed to be supplied on pin 26 of the 50-pin header. But SCSI devices are not required to supply this power; many have jumpers to enable or disable it. So it is possible to have a proper termination setup, but no power provided to the terminators. Naturally, this will cause problems. Make sure that at least one device is supplying termination power to the SCSI bus, preferably the controller, since external devices may be turned off, which would deprive the rest of the bus of termination power.

Cable Configurations

Internal SCSI devices are usually connected with 50-conductor ribbon cable. 50-pin IDC connectors are crimped onto the cable for each device to be attached. "Stub" cables of no more than 3 centimeters off the main cable are allowed by the SCSI standard, but it's better to avoid them altogether by running the cable direct from one device to the next, with no branches off the main bus at all.

External SCSI device cables can use several connectors: Centronics 50-pin, DB25, or high-density 50-pin (commonly referred to as SCSI-2, since many Fast SCSI-2 adapters use this type of connector). Adapter cables may have any combination of these three basic types.

The SCSI standard states that the total length of the SCSI bus, including internal and external cable, must not exceed six meters. In practice, some devices and cable combinations may limit this severely, particularly cables with DB25 connectors (since Apple created the DB25 "pseudo-SCSI" cable by simply discarding all those "extra" grounds that helped make SCSI capable of running long distances in the first place). Conversely, some SCSI bus implementations can go farther than the standard suggests.

Unit Numbers

Each SCSI device (including the controller) has a unit number between 0 and 7 assigned to it by the user. These numbers are usually set as a binary number with three jumpers. Controllers often have no jumpers, either requiring software to change their unit number, or simply not being able to change their unit number at all. Standard Amiga controllers of either type default to SCSI unit number 7.

The rules regulating unit numbers are pretty simple: each device must have a unique unit number. (There is no physical "order" in which the unit numbers must occur; you can use any order or combination of numbers, as long as they're unique.)

Since the Amiga scans the SCSI bus for bootable devices starting with unit 0 and proceeding to unit 7, it is advised that you assign unit number 0 to the boot hard drive, and set "HiID" to "On" for this drive in the Rigid Disk Block (RDB). This will prevent the system for looking for other hard drives with a higher boot priority, making for the quickest booting possible, and preventing the system from trying to boot off of a higher-numbered CD-ROM drive. (Check the Aminet disk/misc directory for RDB utility programs.)

Example Bus Connections

These examples show connections to the A2091 controller (see Drives/

A2091 Reference
) , but other controllers will be similar.

In each case, the 200M hard drive is used as the boot drive, and the "HiID" flag is set to "On" in this drive's Rigid Disk Block. The HiID flag may be called by another name, like LastDrive or HighDrive.

Example 1: 2091 controller, internal 200M SCSI-1 hard drive. Cable connections are 50-conductor ribbon.

2091	-----	200M SCSI-1
Terminated (Unit #7)		Terminated Unit #0

Example 2: 2091 controller, internal 200M SCSI-1 hard drive, internal 540M SCSI-2 hard drive. Cable connections are 50-conductor ribbon.

2091	-----	200M SCSI-1	-----	540M SCSI-2
Terminated (Unit #7)		Not Terminated Unit #0		Terminated Unit #1

Example 3: 2091 controller, internal 200M SCSI-1 hard drive, internal 540M SCSI-2 hard drive, external SCSI-2 CD-ROM drive. The cable from the CD-ROM drive to the A2091 is a Centronics 50-pin to DB25 adapter cable, and the internal cables are 50-conductor ribbon.

An active terminator is attached to the last available external SCSI connector on the CD-ROM drive. Note that the terminating resistors on the A2091 have been removed so that the SCSI bus is terminated only at the ends.

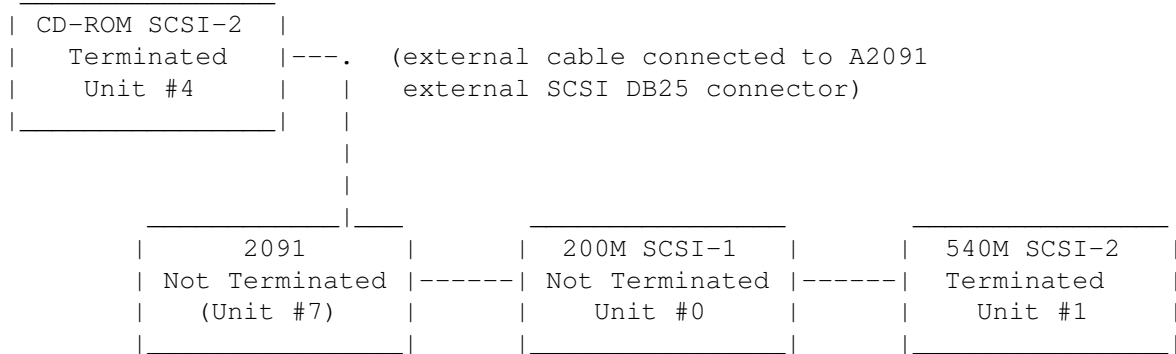

1.54 monitors

Monitors

1081 Reference

1084 Reference

1085 Reference

1940/1942 Reference

1950 Reference

1960 Reference

Idek Iiyama Vision Master 17 (MF-8617) Reference

Mitsubishi DiamondScan AUM-1381A Reference

1.55 1081 reference

1081 Reference

The 1081 is a 14-inch monitor manufactured by Philips for the European market, and similar to the

1084

, with SCART and composite video connectors.

The 1081 may have only been distributed in Europe.

A common problem is for the monitor to "pop," then go dark. Hitting it may bring back the picture. This is often caused by cold or cracked solder joints on the flyback transformer, which resoldering should cure.

Specifications

Sync Frequency: 15.6 kHz Horizontal

Dot Pitch: 0.39mm or 0.42 mm

Sound Output: 1.0 W RMS/Channel at 5% maximum THD

Input Connectors: One permanently attached HDD15 and Audio R/L

Pin-Outs (SCART Euroconnector)

Pin 1: Unused
Pin 2: Audio Input (0.5 Vrms/ > 10Kohms)
Pin 3: Unused
Pin 4: Audio Ground
Pin 5: Blue Ground
Pin 6: Audio Input (0.5 Vrms/ > 10Kohms)
Pin 7: Blue Video (0.7 Vpp/ 75 ohms)
Pin 8: Unused
Pin 9: Green Ground
Pin 10: Unused
Pin 11: Green Video (0.7 Vpp/ 75 ohms)
Pin 12: Unused
Pin 13: Red Ground
Pin 14: Unused
Pin 15: Red Video (0.7 Vpp/ 75 ohms)
Pin 16: Fast Blanking
Pin 17: CVBS Ground
Pin 18: Fast Blanking Ground
Pin 19: Unused
Pin 20: CVBS Input (1 Vpp/ 75 ohms, sync for linear RGB input)
Pin 21: Screening Plug

Pin-Outs (Digital RGB 8-Pin DIN)

Pin 1: Status Computer (?)
Pin 2: Red
Pin 3: Green
Pin 4: Blue

Pin 5: Intensity
Pin 6: Ground
Pin 7: Horizontal Sync or Composite Sync
Pin 8: Vertical Sync

1.56 1084 reference

1084 Reference

The 1084 and its variants (1084S, 1084S-P, 1084-P, 1084S-P2, 1084-D, 1084S-D, and 2080) are all 15.75 kHz monitors. They do not handle AGA "double" screenmodes, nor will they display the deinterlaced output from the A2320 Amber board or the motherboard deinterlaced output on an A3000. However, they will show all normal 15.75 kHz displays, and many (most? all?) of the 1084 versions have a separate input for composite video.

The 1084 is usually a variation of the Philips CM8833 monitor; the 1084S-D was made by Daewoo (as was the 1084D, probably). The display tubes used in these monitors were made by Orion, Toshiba, Hitachi, and Samsung.

Common Problems

- * The door covering the front-panel controls is typically broken off.
- * The attached cables or connectors on some models tended to fail, causing loss of color.
- * Failed or insufficient insulation may cause arcing.
- * The power switch may partially fail, causing separate parts of the monitor to power down.

Only the six-pin DIN connectors are used for analog RGB. Some 1084 monitors also have digital RGB (PC clone CGA) inputs.

Other Notes

- * The 2080 is a long-persistence phosphor, .39 mm dot pitch.

Specifications

Sync Frequency 15.75 kHz (NTSC; 15.6 kHz PAL)

Pin-Outs (6-Pin DIN)

Pin 1: Green
Pin 2: Horizontal Sync
Pin 3: Ground
Pin 4: Red
Pin 5: Blue
Pin 6: Vertical Sync

2080 Pin-Outs (SCART Euroconnector)

Pin 1: Unused
Pin 2: Audio Input (0.5 Vrms/ > 10Kohms)

Pin 3: Unused
Pin 4: Audio Ground
Pin 5: Blue Ground
Pin 6: Audio Input (0.5 Vrms/ > 10Kohms)
Pin 7: Blue Video (0.7 Vpp/ 75 ohms)
Pin 8: Unused
Pin 9: Green Ground
Pin 10: Unused
Pin 11: Green Video (0.7 Vpp/ 75 ohms)
Pin 12: Unused
Pin 13: Red Ground
Pin 14: Unused
Pin 15: Red Video (0.7 Vpp/ 75 ohms)
Pin 16: Fast Blanking
Pin 17: CVBS Ground
Pin 18: Fast Blanking Ground
Pin 19: Unused
Pin 20: CVBS Input (1 Vpp/ 75 ohms, sync signal for linear RGB input)
Pin 21: Screening Plug

2080 Pin-Outs (Digital RGB 8-Pin DIN)

Pin 1: Status Computer (?)
Pin 2: Red
Pin 3: Green
Pin 4: Blue
Pin 5: Intensity
Pin 6: Ground
Pin 7: Horizontal Sync or Composite Sync
Pin 8: Vertical Sync

1.57 1085 reference

1085 Reference

The 1085(S) is a cost-reduced version of the 1084, with lower resolution (.52 mm dot pitch) and no non-glare screen treatment. Like the 1084, the 1085 is a fixed-frequency 15.75 kHz monitor, and is not compatible with most AGA screen modes.

Pin-Outs (DB9)

Pin 1: Ground
Pin 2: Ground
Pin 3: Red
Pin 4: Green
Pin 5: Blue
Pin 6: Unused
Pin 7: Composite Sync
Pin 8: Unused
Pin 9: Unused

1.58 1940 reference

1940/1942 Reference

This monitor is a 13-inch bisync (not true multisync) monitor built by Samsung for Commodore. It has two ranges of sync frequencies to match both normal (15.75 kHz) and doubled screen modes. The 1942 differs from the 1940 only in that it has a smaller dot pitch. MonEd may be useful in getting the picture to fill the entire screen. Both variations feature stereo speakers.

Specifications

Sync Frequency: 15.6-15.8 kHz and 27.3-31.5 kHz Horizontal
47 Hz to 75 Hz Vertical

Dot Pitch: 0.39 mm (1940)
0.28 mm (1942)

Sound Output: 1.0 W RMS/Channel at 5% maximum THD

Input Connectors: One permanently attached HDD15 and Audio R/L

Pin-Outs (HDD15)

Pin 1: Red
Pin 2: Green
Pin 3: Blue
Pin 4: Unused
Pin 5: Unused
Pin 6: Red Ground
Pin 7: Green Ground
Pin 8: Blue Ground
Pin 9: Unused
Pin 10: Digital Ground
Pin 11: Digital Ground
Pin 12: Unused
Pin 13: Horizontal Sync
Pin 14: Vertical Sync
Pin 15: Unused

1.59 1950 reference

1950 Reference

The 1950 monitor was actually produced by a company called AOC. Parts may still be available direct (although there have been conflicting reports). The AOC model of the monitor was known as the AOC CM314. The tube is made by Hitachi.

Specifications

Sync Frequency: 15 kHz to 35 kHz Horizontal
50 Hz to 80 Hz Vertical

Dot Pitch: 0.31 mm

Input Connectors: One permanently attached HDD15 (AOC CM314 also has an attached DB9 for digital RGB.)

Pin-Outs (HDD15)

Pin 1: Red
Pin 2: Green
Pin 3: Blue
Pin 4: Unused
Pin 5: Test
Pin 6: Ground
Pin 7: Ground
Pin 8: Ground
Pin 9: Unused
Pin 10: Ground
Pin 11: Ground
Pin 12: Unused
Pin 13: Horizontal Sync
Pin 14: Vertical Sync
Pin 15: Unused

Manufacturer

AOC International
311 Sinclair Frontage Road
Milpitas CA 95035
(408) 956-1070

Common Problems

A sync problem may be caused by the monitor detecting sync on the Green input and then disabling the horizontal and vertical sync inputs. Removing the 10K R854 resistor or the 10uF C812 capacitor on the small vertical board may fix this.

The analog/TTL switch appears to be prone to failure. However, if switching the switch brings back the picture, it may actually be that the 74LS123 (IC805) on the same board is failing. The suggested course of action is to replace (or at least resolder) this chip first, since it's a commonly available part.

Another common problem is the failure of a multifunction sync chip. Replacements should be available from Sony.

1.60 1960 reference

1960 Reference

The 1960 may have been made by Daewoo (Korea) or a Taiwan company. The tube is made by Hitachi.

A common problem involves a component that is insulated with electrical tape (inadequately) from the factory, resulting in arcing. Replacing this insulation can cure the problem.

Typical failures also result from cold solder joints on the 1960 boards, which can be repaired by resoldering. Additionally, some solder joints (such as those on the flyback transformer) tend to go bad with age. Resoldering them may cure arcing problems.

The screen size adjustment pots may be prone to failure, making adjustments difficult.

Specifications

Sync Frequency: 15 kHz to 38.0 kHz Horizontal
50 Hz to 87 Hz Vertical

Dot Pitch: 0.29 mm or .31 mm

Input Connectors: HDD15 (Analog RGB), DB9 (Digital RGB)

Pin-Outs (HDD15 Analog RGB)

Pin 1: Red
Pin 2: Green
Pin 3: Blue
Pin 4: Monitor Sense, Ground to Pin 10
Pin 5: Ground
Pin 6: Red Ground
Pin 7: Green Ground
Pin 8: Blue Ground
Pin 9: Unused
Pin 10: Digital Ground
Pin 11: Jumper to Pin 10
Pin 12: Unused
Pin 13: Horizontal Sync
Pin 14: Vertical Sync
Pin 15: Jumper to Pin 10

Pin-Outs (DB9 Digital RGB) (EGA?)

Pin 1: Ground
Pin 2: Red Prime
Pin 3: Red Video
Pin 4: Green Video
Pin 5: Blue Video
Pin 6: Green Prime
Pin 7: Blue Prime
Pin 8: Horizontal Sync
Pin 9: Vertical Sync

1.61 idek iiyama vision master 17 (mf-8617) reference

Idek Iiyama Vision Master 17 (MF-8617) Reference

This is a fairly popular monitor for use with the Amiga, since it is a high quality, relatively inexpensive 17-inch monitor that can sync down to about 23.5 kHz, and therefore works with most (all?) AGA "double" screenmodes. All presets and controls are digital, set through three front-panel buttons and an LCD display. The image can easily be expanded to fill the screen in all modes. (See Boards/

A2320 'Amber' Reference

for information on the A2320

'Amber' board that may be used with this monitor.)

Specifications

Sync Frequency: 23.5 kHz to 86.0 kHz Horizontal
50 Hz to 120 Hz Vertical

Resolution: Maximum 1280 x 1024 at 80 Hz

Input Connectors: Five BNC connectors and one DB15 (not high density)
(A cable is included to connect a HDD15 VGA-type connector to the DB15 connector on the monitor.)

Pin-Outs

DB15:

Pin 1: Red
Pin 2: Red Ground
Pin 3: Green
Pin 4: Green Ground
Pin 5: Blue
Pin 6: Blue Ground
Pin 7: Ground
Pin 8: NC
Pin 9: NC
Pin 10: NC
Pin 11: NC
Pin 12: NC
Pin 13: NC
Pin 14: Horizontal or HV Sync
Pin 15: Vertical Sync

1.62 mitsubishi diamondscan aum-1381a reference

Mitsubishi DiamondScan AUM-1381A Reference

The DiamondScan is one of the few VGA-type multisync monitors that has a composite video input, and that made it relatively common for use on the Amiga (although I believe that Mitsubishi no longer makes this model). The official scan rates cover the range from 15.6 kHz to 36 kHz, so the

DiamondScan should work with all normal Amiga video modes. User controls are standard knobs and buttons, and there are no digital memory features, so using it with the Amiga means that you have to juggle the monitor's picture location settings along with the Amiga overscan and screen position settings. The DiamondScan works fine with the Amber board (see Boards/

A2320 'Amber' Reference
).

One feature of the DiamondScan is particularly applicable to the video production uses of the Amiga: the "Composite/RGB Select" (pin 22) on the DB25 input. Connect this pin through a switch to ground, and then a flip of the switch will select composite video or analog RGB display without reaching for the switches on the back of the monitor.

Specifications

Sync Frequency: 15.6 kHz to 36 kHz Horizontal
45 Hz to 90 Hz Vertical

Resolution: Maximum 800 x 560 (Rated...normally considered
to be an 800x600 monitor.)

Input Connectors: BNC (Composite Video)
DB9 (EGA/CGA/Mono TTL) (DB9-to-DB9 cable was included.)
DB25 (Analog RGB)

Pin-Outs

DB9: (For TTL 16-Color CGA)

Pin 1: Ground
Pin 2: Unused
Pin 3: Red Video
Pin 4: Green Video
Pin 5: Blue Video
Pin 6: Intensity
Pin 7: Unused
Pin 8: Horizontal Sync
Pin 9: Vertical Sync

DB9: (For TTL 64-Color EGA)

Pin 1: Ground
Pin 2: Secondary Red Video
Pin 3: Primary Red Video
Pin 4: Primary Green Video
Pin 5: Primary Blue Video
Pin 6: Secondary Green Video/Intensity
Pin 7: Secondary Blue Video
Pin 8: Horizontal Sync
Pin 9: Vertical Sync

DB9: (For TTL Mono)

Pin 1: Ground

Pin 2: Unused
 Pin 3: Unused
 Pin 4: Unused
 Pin 5: Unused
 Pin 6: High Intensity
 Pin 7: Video
 Pin 8: Horizontal Sync
 Pin 9: Vertical Sync

DB25:

Pin 1: Sync Ground
 Pin 2: Red Video
 Pin 3: Red Video Ground
 Pin 4: Green Video
 Pin 5: Green Video Ground
 Pin 6: Superimpose Control (YS)
 Pin 7: Superimpose Ground
 Pin 8: Video Input Select (AV)
 Pin 9: Composite Video Input
 Pin 10: Composite Video Ground
 Pin 11: Composite Video Out
 Pin 12: Composite Video Ground
 Pin 13: PGA Mode Control
 Pin 14: Blue Video
 Pin 15: Blue Video Ground
 Pin 16: Horizontal/Composite Sync
 Pin 17: Vertical Sync
 Pin 18: Unused
 Pin 19: Unused
 Pin 20: Unused
 Pin 21: INT (+5V ???)
 Pin 22: Composite/RGB Select (TTL level: Low for RGB, high
 or open for composite.)
 Pin 23: Analog/TTL Select (TTL level: Low for TTL, high
 or open for analog.)
 Pin 24: Remote (TTL level: Low to disable Mode Switch.)
 Pin 25: Shield Ground

1.63 sources

Sources For Components

Opinions in this section are strictly those of the
 Editor

This list includes sources for suppliers of parts and accessories like
 cables and connectors. Suggestions:

- * For general or custom cables and connectors: Dalco or Redmond Cable.
 - * For general board-level parts (not custom Amiga): Digi-Key and JDR.
 - * For custom Amiga parts: Unknown at this point. Suggestions welcome!
-

Altex Electronics

Chip Merchant

Dalco Electronics

Digi-Key Corporation

Hosfelt Electronics

JameCo Electronic Components

JDR Microdevices

Marlin P. Jones & Associates

MCM Electronics

Memory World

Parts Express

Redmond Cable

1.64 altex electronics

Altex Electronics
11342 N IH 35
San Antonio TX 78233-9903
(800) 531-5369
(210) 637-3264 Fax

I've not had a lot of experience with Altex, although they seem okay, and have a pretty good selection of connectors and components at good prices.

1.65 chip merchant

Chip Merchant
4870 Viewridge Avenue
San Diego CA 92123
(800) 426-6375
(619) 268-4774
(619) 268-0874 Fax

So far, I've had limited experience the Chip Merchant, but it's all been good. They have very low prices on SIMMs and common chips like processors.

1.66 dalco electronics

Dalco Electronics
275 Pioneer Boulevard
Springboro OH 45066
(800) 445-5342
(513) 743-8042
(513) 743-9251 Fax
(513) 743-2244 BBS

Extremely large selection of connectors, cables (including the relatively rare SCSI-2 and 2.5-inch IDE hard disk varieties), and pretty much everything in the way of computer assemblies. Oriented towards computer end-users. They will custom-build cables. Service is good, prices are excellent, and their catalog is filled with basically neat stuff.

1.67 digi-key corporation

Digi-Key Corporation
701 Brooks Ave. South
PO Box 677
Thief River Falls MN 56701-0677
(800) 344-4539
(218) 681-3380

Huge assortment of electronic components, including chips, heat sinks, cables, connectors, fans, and every other electronic part you can think of except DB23s. Prices tend to be a little higher, which is offset somewhat by the fact that they have such a large selection. Their catalog can be considered a reference work. Oriented towards electronics designers and experimenters.

1.68 hosfelt electronics

Hosfelt Electronics
2700 Sunset Boulevard
Steubenville OH 43952-1158
(800) 524-6464
(800) 524-5414 Fax

Source for Panasonic replacement fans and other parts. I've been very happy with this company: they have things in stock, ship quickly, and have extremely low prices.

1.69 jameco electronic components

JameCo Electronic Components
1355 Shoreway Road
Belmont CA 94002-4100
(800) 831-4242
(415) 592-2503 Fax

Large selection of chips, power supplies, and other electronic components, including some that can be extremely difficult to find elsewhere.

1.70 jdr microdevices

JDR Microdevices
1850 South 10th Street
San Jose CA 95112-4108
(800) 538-5000 Orders (24-Hour)
(800) 538-5005 Fax
(800) 538-5002 Tech Support
(408) 494-1430 BBS

Chips, cables, hard drives, generic computer parts. Oriented towards the end-user, quick to deliver, inexpensive, and nice on the phone.

1.71 marlin p. jones & associates

Marlin P. Jones & Associates
PO Box 12685
Lake Park FL 33403-0685
(407) 848-8236
(407) 844-8764 Fax

Chips, connectors, electronics and computer parts, much of which is surplus. They sometimes have parts unavailable elsewhere, like blue LEDs. Oriented towards electronics experimenters and designers.

1.72 mcm electronics

MCM Electronics
650 Congress Park Drive
Centerville OH 45459-4072
(800) 543-4330

(513) 434-6959 Fax

Large assortment of parts. Oriented towards electronic repair shops.

1.73 memory world

Memory World
3392 Progress Drive, Suite B
Bensalem PA 19020-5899
(215) 244-7930
(215) 244-7932 Fax

Source for SIMMs, ZIPs, other memory, Motorola processors. And they even know what an Amiga is! Prices tend to be excellent.

1.74 parts express

Parts Express
340 E. First Street
Dayton OH 45402-1257
(800) 338-0531
(513) 222-4644 Fax

Chips, cables, other parts. Oriented towards electronic repair shops.

1.75 redmond cable

Redmond Cable
(206) 882-2009
(206) 883-1430 Fax

Excellent source of very unusual cables and connectors. They will custom-build cables or just sell the parts. They had SCSI-2 panel mount female connectors, which I was unable to locate anywhere else.

1.76 editor

Editor And Compiler Of The A4000 Hardware Guide

Warren Block
602 St. James
Rapid City SD 57701-3658
(605) 342-1632 (voice)
wblock@silver.sdsmt.edu

Music that may have contributed to the mood of this guide, and that has definitely influenced me:

Pink Floyd: Wish You Were Here, Meddle, The Division Bell

Roger Waters: Amused To Death

Peter Gabriel: Us, Shaking The Tree

1.77 credits

Credits

People who have contributed information to this document, either directly or by posting public Usenet or BBS messages that have revealed information that was incorporated into this document:

Ralph Babel	Scott Goffman	John Palmer
Chuck Baker	Denny Goodrich	Michael Perbix
Volker Barthelmann	Francois Groleau	Kenneth Perto
Gary Bates	Dave Haynie	Dave Platt
Rainer Benda	Gregory Hellenen	Kent Polk
Warren Block	Kjell Irgens	Thomas Radtke
Martin Blom	Brian Jones	Mike Redrobe
Keith Burns	Dan Karlsson	Greg Scott
Tom Conlin	Oliver Kastl	Olaf 'Rhialto' Seibert
Randy Consemulder	John Kelly	Stephen Smith
Steve Crippen	Mario Kemper	Jeroen Steenblik
John Crookshank	Dr. Peter Kittel	Ben Sutter
Dale Currie	Paul Kolenbrander	Derek Taylor
Richard Davey	Jeff Koons	Mitch Thompson
Joachim Deussen	Randy Kruszka	Calum Tsang
Jim Drew	Erik Lindberg	Doug Warner
Peter Ducker	Don Maddox	Matt Weatherford
Jacob Ellis	Michael Martin	Thomas Weeks
Michael van Elst	Peter McGavin	Ulrich Weise
Bernd Ernesti	Gerry Murphy	Lothar Werzinger
Jeff Gill	Patrik Nordvall	Heinz Wrobel

I'd like to thank everyone for their graciousness in sharing this very valuable information with the world, and in putting up with my seemingly endless questions on the Amiga 4000. Thank you all!

Finally, a special note of thanks to Urban Müller, the main administrator of Aminet, for the Aminet itself.

1.78 what's new with this version

What's New With This Version

New Sections

A2060 Reference

Reference on the A2060 Arcnet board.

Ariadne Reference

Reference on the Ariadne Ethernet board.

Chip Merchant

Source listing for the Chip Merchant.

Definitive Buster

Dave Haynie describes Buster/A3640 problems and cures.

IDE Drive Problems

Common problems with IDE drives.

Oktagon Reference

Reference on the Oktagon SCSI controller.

Other Video Problems

Other sources of video troubles.

SCSI Drive Problems

Common problems with SCSI drives.

SCSI Examples

Example SCSI configurations and definitions.

VGA Monitor Pin-Outs

Standard VGA connections.

Enhanced Or Revised Sections

-5V Power Problems

1081 Reference

1084 Reference

1940 Reference

1950 Reference

1960 Reference

A2091 Reference

Dalco Electronics

Dead Machine Problems

Emplant Reference

Hosfelt Electronics

Motherboard Jumpers

Power-Up Self-Test
Processor Cooling
Warp Engine Reference

1.79 Index

Index

-5V Power Problems
1081 Reference
1084 Reference
1085 Reference
1940 Reference
1950 Reference
1960 Reference
68030 Processor Board Reference
A2060 Reference
A2091 Reference
A2320 Reference
A3640 Reference
Altex Electronics
Ariadne Reference
Backplane Problems
Battery Problems
Boards
Cable Routing Problems
Chip Merchant
Common Problems
Common Questions
Connecting VGA Monitors

Connector Pin-Outs

Credits

Dalco Electronics

Dead Machine Problems

Definitive Buster

Digi-Key Corporation

Drives

Editor

Emplant Reference

External Floppy Port Pin-Outs

External SCSI Connector

Fan Problems

Green Display Problems

Hosfelt Electronics

IDE Drive Problems

Idek Iiyama Vision Master 17 (MF-8617) Reference

Internal Floppy Connector Pin-Outs

Internal IDE Hard Disk Connector Pin-Outs

Internals

Introduction

JameCo Electronic Components

JDR Microdevices

Joystick Port Pin-Outs

Keyboard Port Pin-Outs

Keyboard Self-Test

Main

Marlin P. Jones & Associates

MCM Electronics

Memory World

Mitsubishi DiamondScan AUM-1381A Reference

Monitors

Motherboard Jumpers
 Oktagon Reference

Other Video Problems

Parallel Port Pin-Outs

Parts Express

Power-Up Self-Test

Processor Board Mounting

Processor Cooling

Redmond Cable

SCSI Drive Problems

SCSI Examples

SCSI Pin-Outs

SCSI Reselect Problems

Seagate ST3096A/ST3120A/ST3144A Reference

Serial Port Pin-Outs

Slow A2091 Problems

Sources

Tips

VGA Monitor Pin-Outs

Video Banding Modification

Video Banding Problems

Video Port Pin-Outs

Warp Engine Reference

What's New With This Version

Zorro-III Problems
